



**Net Phone
User Guide**

Publication Information

**Toshiba America Information Systems, Inc.
Telecommunication Systems Division**

Publication Information

Toshiba America Information Systems, Inc., Telecommunication Systems Division, reserves the right, without prior notice, to revise this information publication for any reason, including, but not limited to, utilization of new advances in the state of technical arts or to simply change the design of this document.

Further, Toshiba America Information Systems, Inc., Telecommunication Systems Division, also reserves the right, without prior notice, to make such changes in equipment design or components as engineering or manufacturing methods may warrant.

CIX-UG-NP-VA

Version A, April 2008

Our mission to publish accurate, complete and user accessible documentation. At the time of printing the information in this document was as accurate and current as was reasonably possible. However, in the time required to print and distribute this manual additions, corrections or other changes may have been made. To view the latest version of this or other documents please refer to the Toshiba FYI web site.

Toshiba America Information Systems shall not be liable for any commercial losses, loss of revenues or profits, loss of goodwill, inconvenience, or exemplary, special, incidental, indirect or consequential damages whatsoever, or claims of third parties, regardless of the form of any claim that may result from the use of this document.

THE SPECIFICATIONS AND INFORMATION PROVIDED HEREIN ARE FOR INFORMATIONAL PURPOSES ONLY AND ARE NOT A WARRANTY OF ACTUAL PERFORMANCE, WHETHER EXPRESSED OR IMPLIED. THE SPECIFICATIONS AND INFORMATION ARE SUBJECT TO CHANGE WITHOUT NOTICE. ACTUAL PERFORMANCE MAY VARY BASED ON INDIVIDUAL CONFIGURATIONS, USE OF COLLATERAL EQUIPMENT, OR OTHER FACTORS.

© Copyright 2008

This document is copyrighted by Toshiba America Information Systems, Inc. with all rights reserved. Under the copyright laws, this document cannot be reproduced in any form or by any means—graphic, electronic, or mechanical, including recording, taping, photocopying, without prior written permission of Toshiba. No patent liability is assumed, however, with respect to the use of the information contained herein.

Trademarks

Strata, SD (Secure Digital) and CIX are registered trademarks of Toshiba Corporation.

Stratagy, eManager, My Phone Manager and Info Manager are registered trademarks of Toshiba America Information Systems, Inc.

Windows and Microsoft are registered trademarks of Microsoft.

Trademarks, registered trademarks, and service marks are the property of their respective owners.

TOSHIBA AMERICA INFORMATION SYSTEMS, INC. ("TAIS")

Telecommunication Systems Division License Agreement

IMPORTANT: THIS LICENSE AGREEMENT ("AGREEMENT") IS A LEGAL AGREEMENT BETWEEN YOU ("YOU") AND TAIS. CAREFULLY READ THIS LICENSE AGREEMENT. USE OF ANY SOFTWARE OR ANY RELATED INFORMATION (COLLECTIVELY, "SOFTWARE") INSTALLED ON OR SHIPPED WITH A TAIS DIGITAL SOLUTIONS PRODUCT OR OTHERWISE MADE AVAILABLE TO YOU BY TAIS IN WHATEVER FORM OR MEDIA, WILL CONSTITUTE YOUR ACCEPTANCE OF THESE TERMS, UNLESS SEPARATE TERMS ARE PROVIDED BY THE SOFTWARE SUPPLIER. IF YOU DO NOT AGREE WITH THE TERMS OF THIS LICENSE AGREEMENT, DO NOT INSTALL, COPY OR USE THE SOFTWARE AND PROMPTLY RETURN IT TO THE LOCATION FROM WHICH YOU OBTAINED IT IN ACCORDANCE WITH APPLICABLE RETURN POLICIES. EXCEPT AS OTHERWISE AUTHORIZED IN WRITING BY TAIS, THIS SOFTWARE IS LICENSED FOR DISTRIBUTION THROUGH TAIS AUTHORIZED CHANNELS ONLY TO END-USERS PURSUANT TO THIS LICENSE AGREEMENT.

- License Grant.** The Software is not sold; it is licensed upon payment of applicable charges. TAIS grants to you a personal, non-transferable and non-exclusive right to use the copy of the Software provided under this License Agreement. You agree you will not copy the Software except as necessary to use it on one TAIS system at a time at one location. Modifying, translating, renting, copying, distributing, printing, sublicensing, transferring or assigning all or part of the Software, or any rights granted hereunder, to any other persons and removing any proprietary notices, labels or marks from the Software is strictly prohibited except as permitted by applicable law; you agree violation of such restrictions will cause irreparable harm to TAIS and provide grounds for injunctive relief, without notice, against you or any other person in possession of the Software. You and any other person whose possession of the software violates this License Agreement shall promptly surrender possession of the Software to TAIS, upon demand. Furthermore, you hereby agree not to create derivative works based on the Software. TAIS reserves the right to terminate this license and to immediately repossess the software in the event that you or any other person violates this License Agreement. Execution of the Software for any additional capabilities require a valid run-time license.
- Intellectual Property.** You acknowledge that no title to the intellectual property in the Software is transferred to you. You further acknowledge that title and full ownership rights to the Software will remain the exclusive property of TAIS and/or its suppliers, and you will not acquire any rights to the Software, except the license expressly set forth above. You will not remove or change any proprietary notices contained in or on the Software. The Software is protected under US patent, copyright, trade secret, and/or other proprietary laws, as well as international treaties. Any transfer, use, or copying of the software in violation of the License Agreement constitutes copyright infringement. You are hereby on notice that any transfer, use, or copying of the Software in violation of this License Agreement constitutes a willful infringement of copyright.
- No Reverse Engineering.** You agree that you will not attempt, and if you employ employees or engage contractors, you will use your best efforts to prevent your employees and contractors from attempting to reverse compile, reverse engineer, modify, translate or disassemble the Software in whole or in part. Any failure to comply with the above or any other terms and conditions contained herein will result in the automatic termination of this license and the reversion of the rights granted hereunder back to TAIS.
- Limited Warranty.** THE SOFTWARE IS PROVIDED "AS IS" WITHOUT WARRANTY OF ANY KIND. TO THE MAXIMUM EXTENT PERMITTED BY APPLICABLE LAW, TAIS AND ITS SUPPLIERS DISCLAIM ALL WARRANTIES WITH REGARD TO THE SOFTWARE, EITHER EXPRESS OR IMPLIED, INCLUDING, BUT NOT LIMITED TO, THE WARRANTY OF NON-INFRINGEMENT OF THIRD PARTY RIGHTS, THE WARRANTY OF YEAR 2000 COMPLIANCE, AND THE IMPLIED WARRANTIES OF MERCHANTABILITY AND FITNESS FOR A PARTICULAR PURPOSE. THE ENTIRE RISK AS TO THE QUALITY AND PERFORMANCE OF THE SOFTWARE IS WITH YOU. NEITHER TAIS NOR ITS SUPPLIERS WARRANT THAT THE FUNCTIONS CONTAINED IN THE SOFTWARE WILL MEET YOUR REQUIREMENTS OR THAT THE OPERATION OF THE SOFTWARE WILL BE UNINTERRUPTED OR ERROR-FREE. HOWEVER, TAIS WARRANTS THAT ANY MEDIA ON WHICH THE SOFTWARE IS FURNISHED IS FREE FROM DEFECTS IN MATERIAL AND WORKMANSHIP UNDER NORMAL USE FOR A PERIOD OF NINETY (90) DAYS FROM THE DATE OF DELIVERY TO YOU.
- Limitation Of Liability.** TAIS' ENTIRE LIABILITY AND YOUR SOLE AND EXCLUSIVE REMEDY UNDER THIS LICENSE AGREEMENT SHALL BE AT TAIS' OPTION REPLACEMENT OF THE MEDIA OR REFUND OF THE PRICE PAID. TO THE MAXIMUM EXTENT PERMITTED BY APPLICABLE LAW, IN NO EVENT SHALL TAIS OR ITS SUPPLIERS BE LIABLE TO YOU FOR ANY CONSEQUENTIAL, SPECIAL, INCIDENTAL OR INDIRECT DAMAGES FOR PERSONAL INJURY, LOSS OF BUSINESS PROFITS, BUSINESS INTERRUPTION, LOSS OF BUSINESS INFORMATION, DATA, OR ANY OTHER PECUNIARY LOSS OF ANY KIND ARISING OUT OF THE USE OR INABILITY TO USE THE SOFTWARE, EVEN IF TAIS OR ITS SUPPLIER HAS BEEN ADVISED OF THE POSSIBILITY OF SUCH DAMAGES. IN NO EVENT SHALL TAIS OR ITS SUPPLIERS BE LIABLE FOR ANY CLAIM BY A THIRD PARTY.
- State/Jurisdiction Laws.** SOME STATES/JURISDICTIONS DO NOT ALLOW THE EXCLUSION OF IMPLIED WARRANTIES OR LIMITATIONS ON HOW LONG AN IMPLIED WARRANTY MAY LAST, OR THE EXCLUSION OR LIMITATION OF INCIDENTAL OR CONSEQUENTIAL DAMAGES, SO SUCH LIMITATIONS OR EXCLUSIONS MAY NOT APPLY TO YOU. THIS LIMITED WARRANTY GIVES YOU SPECIFIC RIGHTS AND YOU MAY ALSO HAVE OTHER RIGHTS WHICH VARY FROM STATE/JURISDICTION TO STATE/JURISDICTION.
- Export Laws.** This License Agreement involves products and/or technical data that may be controlled under the United States Export Administration Regulations and may be subject to the approval of the United States Department of Commerce prior to export. Any export, directly or indirectly, in contravention of the United States Export Administration Regulations, or any other applicable law, regulation or order, is prohibited.
- Governing Law.** This License Agreement will be governed by the laws of the State of California, United States of America, excluding its conflict of law provisions.
- United States Government Restricted Rights.** The Software is provided with Restricted Rights. The Software and other materials provided hereunder constitute Commercial Computer Software and Software Documentation and Technical Data related to Commercial Items. Consistent with F.A.R. 12.211 and 12.212 they are licensed to the U.S. Government under, and the U.S. Government's rights therein are restricted pursuant to, the vendor's commercial license.
- Severability.** If any provision of this License Agreement shall be held to be invalid, illegal or unenforceable, the validity, legality and enforceability of the remaining provisions hereof shall not in any way be affected or impaired.
- No Waiver.** No waiver of any breach of any provision of this License Agreement shall constitute a waiver of any prior, concurrent or subsequent breach of the same or any other provisions hereof, and no waiver shall be effective unless made in writing and signed by an authorized representative of the waiving party.
- Supplier Software.** The Software may include certain software provided by TAIS suppliers. In such event, you agree that such supplier may be designated by TAIS as a third party beneficiary of TAIS with rights to enforce the Agreement with respect to supplier's software.

YOU ACKNOWLEDGE THAT YOU HAVE READ THIS LICENSE AGREEMENT AND THAT YOU UNDERSTAND ITS PROVISIONS. YOU AGREE TO BE BOUND BY ITS TERMS AND CONDITIONS. YOU FURTHER AGREE THAT THIS LICENSE AGREEMENT CONTAINS THE COMPLETE AND EXCLUSIVE AGREEMENT BETWEEN YOU AND TAIS AND SUPERSEDES ANY PROPOSAL OR PRIOR AGREEMENT, ORAL OR WRITTEN, OR ANY OTHER COMMUNICATION RELATING TO THE SUBJECT MATTER OF THIS LICENSE AGREEMENT.

Toshiba America Information Systems, Inc.
Telecommunication Systems Division
9740 Irvine Boulevard
Irvine, California 92618-1697
United States of America

5932

DSD 020905

Toshiba America Information Systems, Inc. Telecommunication Systems Division

Limited Warranty

Toshiba America Information Systems, Inc., ("TAIS") warrants that:

- The CIX Attendant Console equipment, such as the PC (except for fuses, lamps, and other consumables) will, upon delivery by TAIS or an authorized TAIS dealer to a retail customer in new condition, be free from defects in material and workmanship for twelve (12) months after delivery.
- And that the Toshiba telephone equipment (except for fuses, lamps, and other consumables) will, upon delivery by TAIS or an authorized TAIS dealer to a retail customer in new condition, be free from defects in material and workmanship for twenty-four (24) months after delivery.

This warranty is void (a) if the equipment is used under other than normal use and maintenance conditions, (b) if the equipment is modified or altered, unless the modification or alteration is expressly authorized by TAIS, (c) if the equipment is subject to abuse, neglect, lightning, electrical fault, or accident, (d) if the equipment is repaired by someone other than TAIS or an authorized TAIS dealer, (e) if the equipment's serial number is defaced or missing, or (f) if the equipment is installed or used in combination or in assembly with products not supplied by TAIS and which are not compatible or are of inferior quality, design, or performance.

The sole obligation of TAIS or Toshiba Corporation under this warranty, or under any other legal obligation with respect to the equipment, is the repair or replacement by TAIS or its authorized dealer of such defective or missing parts as are causing the malfunction with new or refurbished parts (at their option). If TAIS or one of its authorized dealers does not replace or repair such parts, the retail customer's sole remedy will be a refund of the price charged by TAIS to its dealers for such parts as are proven to be defective, and which are returned to TAIS through one of its authorized dealers within the warranty period and no later than thirty (30) days after such malfunction, whichever first occurs.

Under no circumstances will the retail customer or any user or dealer or other person be entitled to any direct, special, indirect, consequential, or exemplary damages, for breach of contract, tort, or otherwise. Under no circumstances will any such person be entitled to any sum greater than the purchase price paid for the item of equipment that is malfunctioning.

To obtain service under this warranty, the retail customer must bring the malfunction of the machine to the attention of one of TAIS' authorized dealers within the twenty-four (24) month period and no later than thirty (30) days after such malfunction, whichever first occurs. Failure to bring the malfunction to the attention of an authorized TAIS dealer within the prescribed time results in the customer being not entitled to warranty service.

THERE ARE NO OTHER WARRANTIES FROM EITHER TOSHIBA AMERICA INFORMATION SYSTEMS, INC., OR TOSHIBA CORPORATION WHICH EXTEND BEYOND THE FACE OF THIS WARRANTY. ALL OTHER WARRANTIES, EXPRESS OR IMPLIED, INCLUDING THE WARRANTIES OF MERCHANTABILITY, FITNESS FOR A PARTICULAR PURPOSE, AND FITNESS FOR USE, ARE EXCLUDED.

No TAIS dealer and no person other than an officer of TAIS may extend or modify this warranty. No such modification or extension is effective unless it is in writing and signed by the vice president and general manager, Telecommunication Systems Division.

WARRANTIES FOR NON-TOSHIBA BRANDED THIRD PARTY PRODUCTS

A valuable element of Toshiba's product strategy is to offer our customers a complete product portfolio. To provide this value to our customers at the most optimal prices, we offer both Toshiba-branded and third-party manufactured products that support our Toshiba Strata CIX product portfolio. Similar to other resellers of software, hardware and peripherals, these third-party manufactured products carry warranties independent of our Toshiba limited warranty provided with our Toshiba-branded products. Customers should note that third-party manufacturer warranties vary from product to product and are covered by the warranties provided through the original manufacturer and passed on intact to the purchaser by Toshiba. Customers should consult their product documentation for third-party warranty information specific to third-party products. More information may also be available in some cases from the manufacturer's public website.

While Toshiba offers a wide selection of software, hardware and peripheral products, we do not specifically test or guarantee that the third-party products we offer work under every configuration with any or all of the various models of the Toshiba Strata CIX. Toshiba does not endorse, warrant nor assume any liability in connection with such third party products or services. If you have questions about compatibility, we recommend and encourage you to contact the third-party software, hardware and peripheral product manufacturer directly.

Contents

Introduction

Organization.....	v
Conventions	vi
Related Documents/Media.....	vii

Chapter 1 – The Grand Tour

The Main Screen	2
The Streamlined View	2
Expanded View.....	5
Screen Docked Views.....	7
Net Phone Main Menu.....	7
The Side Window Screen.....	9
Call Handler Mode	9
Buttons Mode.....	10
Companion Application Windows.....	11
Skins.....	12
To Change Skin Selection	12

Chapter 2 – Net Phone Settings

Preferences	13
General Tab	14
Dialing Tab	20
Docking Tab	25
Advanced Tab.....	26
Setting Up Hot Key Dialing & Popup	29
Setting Shortcut Keys	29

Contents

Chapter 3 – User-Defined Actions

Options Buttons	30
Option Button Key Types	31
User Programmable Keys	39
To Initialize Key	39
To Swap Keys	39
To Copy This Key	39
To Change Key	40

Chapter 3 – User-Defined Actions

Creating Actions	47
Attach Acct Code	48
Export Call Info	49
Log Info to File	49
Lookup in Outlook	50
Minimize Phone Screen	50
Modify Call Information	51
Play WAV File	53
Pop External Web Browser	53
Pop Internal Web Browser	54
Popup Call Info Screen	56
Popup Phone Screen	57
Run another Program	58
Send DDE Msg	59
Send Keystrokes to a Program	60
Set Phone Do Not Disturb	63
Set Phone Status Message	64
Set Phone Forwarding	64
System/PBX Command	65
Transfer Call	66
Action Variables	67
Call Variables	67
System Variables	69
Exporting Actions	70
Importing Actions	71
Testing Actions	72

Chapter 4 – Using Net Phone Features

Call Handling Features73
 Making Outgoing Calls.....73
 Answering Calls.....75
 Transferring Calls76
 Viewing Extra Call Information77
 Holding Calls78
 Phone Feature Operation.....79
 Status Messages79
 Call Forwarding80
 Call Center Features.....81
 Logging In or Out81
 Changing Agent Status82

Chapter 5 – Connecting Headsets

Plantronics Wireless Headset83
 CS50-USB and CS60-USB DECT83
 Installation84
 Headset Controls and Operation.....85
 Net Phone Audio Setup Screen.....86
 Trouble Shooting87

Chapter 6 – Using Microsoft Outlook

Dialing from within Outlook89
 Incoming Calls89
 While on a Call91
 Integrating with Outlook Calendar92
 Step 1: Create Actions to set and clear the DSS Message92
 Step 2: Create Personal Call Handler Rules93
 Step 3: The Final PCH Rules94

Contents

Chapter 7 – Personal Call Handler

Chapter 7 – Personal Call Handler

Creating Personal Call Handling Rules	96
Like Matches.....	104
Unlike Matches	105
Export Rules.....	106
Importing Rules	107

Chapter 8 – Using Companion Applications

Directories	109
Sorting Entries	109
Finding Entries.....	110
Extension Directory	110
Speed Dial Directory	112
Call History.....	113
Browser Window	118
Presence Viewer.....	119
Other Applications	122
Chat.....	122
Personal Power Dialer	122
Replay	122

Index	123
--------------------	------------

Introduction

This user guide describes how to use the Toshiba Net Phone software with Strata CIX670, CIX200, CIX100, CIX100-S, and CIX40 telephone systems:

Organization

- **Chapter 1 – The Grand Tour** provides an overview of the Net Phone buttons and screens.
- **Chapter 2 – Net Phone Settings** covers the customizable settings.
- **Chapter 3 – User-Defined Actions** includes setting up actions for personal call handling and programmable keys.
- **Chapter 4 – Using Net Phone Features** shows how to use PBX features from Net Phone.
- **Chapter 5 – Connecting Headsets** describes the user information when connecting to a Plantronics USB Wireless headset.
- **Chapter 6 – Using Microsoft Outlook** explains the interactions between Net Phone and Outlook.
- **Chapter 7 – Personal Call Handler** explains the details of personal call handler feature of Net Phone.
- **Chapter 8 – Using Companion Applications** explains how to use applications, such as Call History, Extension Directory, Feature Directory, Personal Speed Dial Directory, Extra Buttons, Presence, and an Integrated Web Browser.

Conventions

Conventions	Description
Note	Elaborates specific items or references other information. Within some tables, general notes apply to the entire table and numbered notes apply to specific items.
Important!	<i>Calls attention to important instructions or information.</i>
Extension Number	<p>Press to answer a call to the Extension Number. Each station can have multiple extension buttons. Incoming calls ring the extension button(s) from the top down. For example, station 10's extensions ring 10-1 first, then 10-2, 10-3, and 10-4. A station is considered busy when all extensions are being used.</p> <p>Note The naming convention for DKT assignments within Toshiba is Directory Numbers. For clarity and ease of understanding, the terms Extension Number and Phantom Extension Number will be used in this document in lieu of PDN and PhDN.</p>
Arial Bold	Represents telephone buttons.
+	<p>shows a multiple PC keyboard or telephone button entry. Entries without spaces between them show a simultaneous entry. Example: Delete+Enter.</p> <p>Entries with spaces between them show a sequential entry. Example: # + 5.</p>
Tilde (~)	Means "through." Example: 350~640 Hz frequency range.
See Figure 10	Grey words within the printed text denote cross-references. In the electronic version of this document (Library CD-ROM or FYI Internet download), cross-references appear in blue hypertext.

Related Documents/Media

Note Some documents listed here may appear in different versions on the CD-ROM or in print. To find the most current version, check the version/date in the Publication Information on the back of the document's title page.

Refer to the following for more information:

- Strata CIX Net Phone System Administrator Manual
- Net Phone On-line Help

This page is intentionally left blank.

The Net Phone works with Net Server to provide a small but powerful "PC-Phone" for use by telephone users to provide productivity enhancements.

The Net Phone is designed to run on a PC with Microsoft® Windows '98, Windows NT 4.0, Windows 2000, Windows XP or 32-bit Windows Vista operating systems connected to a standard TCP/IP network with the Net Server. The Net Server must be installed with the proper software license(s) for Net Phone to operate correctly. Net Phone will operate in Demo Mode if the appropriate licenses are unavailable. Demo mode lets you use the software for Demonstration purposes only for a limited period of time.

Net Phone provides the following major functions:

- It allows you to place, answer, handle, view, and manage phone calls all from your computer screen, keyboard, and mouse.
- Using the VoIP Audio capabilities can provide a complete speech path when using a PC with the proper speech component support.
- It allows you to setup rules and actions to automatically activate when calls arrive even while you are away.
- It provides the glue to easily interface with many popular programs (like Microsoft Outlook, Goldmine, ACT, etc.). This allows you to dial from and “screen-pop” into these programs or the Internet/Intranet.

The Main Screen

This section gives an overview of the main user interface of the Net Phone, including the buttons, displays, and indicators, which allow you to easily and efficiently operate your phone. Net Phone provides two views, Streamlined and Expanded, allowing you to operate using only the space on your screen that you want.

Note You can easily change the color scheme and appearance of your Net Phone by right-clicking your mouse on the logo and selecting one of the “Skins” on page 6 from the Phone colors menu.

The Streamlined View

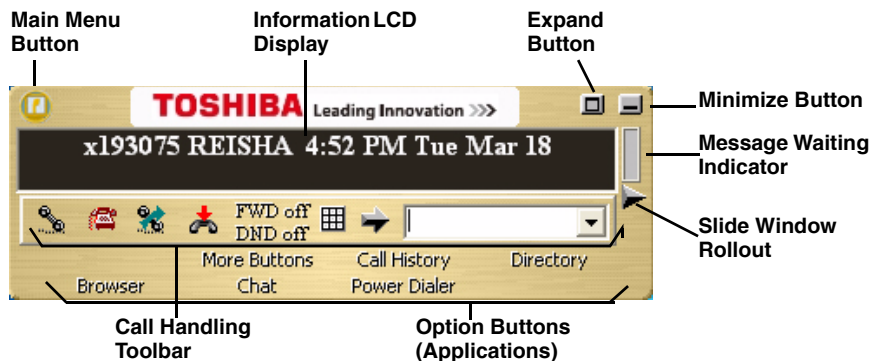

In “Streamlined” view Net Phone consumes minimal screen space but still provides the user with indicators, information, and buttons to effectively operate the phone. This view is most effective when users handle one call at a time, or have very little available screen space available. Below is a sample view and information about the various parts of Net Phone.



Button / Icon	Description
Main Menu	Click this button to access Net Phone configuration menus and Help.
Information LCD Display	This window simulates a phone LCD and provides different types of information depending on current status. If your phone is idle, it shows the date/time, Extension number, and current Name. While a call is active on your phone it shows information about the call – Duration, CallerID or Name (if present.) When a call is active in the window, right-click on the LCD to access to popup a menu of call control options.
Expand Button	Used to change the phone to/from its "Streamlined" view and its "Expanded" view.
Minimize Button 	Hides Net Phone into the system tray. Simply click on the Net Phone icon (shown left) in the system tray to return the Net Phone to the screen.
Message Waiting Indicator	This indicator blinks a Red light when you have messages waiting.
Side Window Rollout Button	Press this button to rollout a side window that has additional programmable buttons.
Options Buttons (Applications)	A number of optional functions and companion programs can be configured to add significant functionality to the Net Phone. Each Companion Application uses an Option Button to provide easy access to the features/functions of the application.
Call Handling Keys	These keys
Call Handling Keys	The first four keys allow you to (from left to right) Answer, Hold, Transfer, and Hang up a call. Should you forget, you can hover your mouse over a key to be reminded what function a key performs.
Do-Not-Disturb Key and Indicator	Displays the current Do Not Disturb status of your phone. Hover the mouse over this area to see the current DND status message. Right-click to change your DND status and message.
Call Forward Key and Indicator	Displays the current "PBX call forwarding" status for your phone. Hover the mouse over this area to see the entire FWD status. Right-click to change your PBX forwarding status and destination.

The Grand Tour

The Main Screen

Button / Icon	Description
Dial Pad Button 	<p>Click the dial pad button to expose and hide the popup Dial Pad. Use the Dial Pad when you reach a recording that says "...Press 1 for sales, 2 for support,...". When this dial pad is displayed you can use your mouse to click the digits to dial or use the number keys or NumLock keypad on your computer keyboard to dial digits.</p> 
Dial Button 	<p>Click the dial button to dial the number shown in the Dial Buffer.</p>
Dial Buffer and Redial Selection	<p>Type a number into this space and press Enter or click the "Dial" button to the left of the box. Click the drop-down arrow to view the last 10 outside phone numbers you dialed. Select a number from the drop-down and press Enter or click Dial to redial that number. You can even Copy/Paste phone numbers from other programs into this window to dial. You may also include letters in the dial number – Net Phone automatically converts the letters to the matching numbers on the telephone keypad (i.e. 1-800-IFLYSWA).</p>

A number of shortcut keys allow you to use the keyboard in place of the mouse to control Net Phone. The list of Shortcut keys can be found using the menu selection Setup>Shortcut Keys. Note: The F1 key is the HELP key and can be pressed at any time to access Help.

Expanded View

In “Expanded” view the Net Phone is enlarged beyond the streamlined view to provide the user with additional buttons, indicators, information to manage multiple simultaneous calls and to access many other features. The follow describes the additional items in the “Expanded” view.



- Volume Controls – These buttons provide control over volume settings on the phone. Note: These volume control settings are only available when the PBX software version supports Volume Control commands.
- Audio Control – The audio control is your line button with a status indicator for that line when using the VoIP audio interface.
- Recording Button & Indicator – The indicator light works in conjunction with OASYS Tracer and OASYS Auto Call Record. Users with appropriate permissions will have this indicator on their Net Phone. If the light is red, this means the user’s call is currently being recorded. If the light is gray, it is not being recorded. The user can click on this button and select ‘Start Recording’ to initiate recording of the call. If the call is being recorded the user can click on the button to terminate the recording.

- **Streamline Button** – Used to change Net Phone back to its "Streamlined" view.
- **Calls Window** – This window displays that status and associated information for each active phone call on the phone. Thus you can easily view and manage multiple phone calls. Right click the mouse on any call to view a menu of options for handling the call (like Hold, Transfer to Voice Mail, Hang Up, etc.).
- **Call Info Indicators** – on the right side of the Call Window is a "Call Info Indicator" that indicates if Extra call information is attached to a call. A gray notebook icon means no information is attached, a blue notebook icon means standard information is attached, and a red notebook icon indicates priority information is attached to the call. Press the Call Notes icon to view or change Notes information on the call. Notes are retained with the call even when you transfer it to another person. You may use Call Notes with an IVR to attach a Customer Name, Credit Card Number, and Zip Code to the call before you answer, saving you from asking the caller for this information.
- **Programmable Buttons** – A number of keys can be easily configured by the user as "Feature" keys, "Speed Dial" keys, "Call" keys, "User Action" keys, etc. To change one of these keys simply Right-Click the mouse over the key and use the Setup Key window to configure the settings for the key (for details on programming these buttons refer to the "User Programmable Keys" on page 22). Note: To expose more programmable buttons click the Side Window rollout button.
- **ACD Buttons** – ACD keys are larger programmable buttons that would give ACD agents easy login/logout of ACD groups. These keys also display the current ACD agent status, and allow agents to control their Wrap-Up mode.

Screen Docked Views

Net Phone provides a screen-docking feature (in Ver. 4.7 and after) where the Net Phone can dock to the top or bottom of your PC screen. When screen docked the Net Phone takes on a very low profile using only a small portion of the screen, and stays accessible even when other applications are maximized. This allows user's to access the features of Net Phone while consuming a minimal amount of PC screen space.

Two screen-docked profiles are available, slim and regular, as shown below:

Slim Screen-docked profile



Regular Screen-docked profile



Most of the phone display, buttons, and controls that appear on each screen-docking profile can be chosen by the user from the “Docking Tab” on page 16 in Net Phone Preferences.

Net Phone Main Menu

To reach Net Phones Main Menu, click on the icon in the upper left-hand corner. The Main Menu opens as shown below:



The Grand Tour

The Main Screen

The File menu item expands into an ability to Change the Login settings, an ability to reset the phone to its default settings, or exit the Net Phone application.



The Setup menu item expands into six sub-menu items for setting parameters for your Net Phone. These include Personal Call Handling rules, User Defined Actions, Preferences, Advanced, when enabled, provides event and call views of activity that has occurred during operation, Shortcut Keys, and Auto Devices Setup. See the Net Phone System Administrator Guide for instructions on enabling the advanced menu item.



The Help menu item expands into Contents for the on-line User Guide, Other Applications has sub-menus for other help files including Net Phone System Administration Guide and application note for the installed integration with an outside application, such as MS Outlook or ACT! 2007.



The Side Window Screen

Click the “Side Window Rollout” button on the main screen to cause the side window to appear just to the right side of the main window or below when the main window is docked. The side window provides access to the Personal Call Handler window and additional programmable buttons can also be reached.

This window can be docked (connected) to or undocked (moved away) from the main window. While docked to the main window, whenever the main window is moved the side window will move with it. And likewise whenever the main window is minimized (into the system tray) or restored, the side window will move with it.

When the side window is undocked, it floats separately from the main window and can be moved and resized separately.

Call Handler Mode

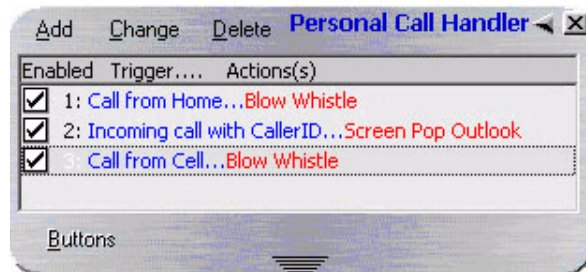

- Call Handler Management Buttons – Used to Add, Change, or Delete Personal Call Handler rules.
- Dock Button – Use to dock the window back to the main screen (if detached) or hide inside the main screen (if attached.)
- Close Button – Use to close the Call Handler window.
- Call Handler Rules Window – Displays the current Call Handler rules along with an enabled (checked) and disabled (unchecked) box per rule. The triggering event is show in blue text while the action to take place is shown in red text for easier viewing.
- Buttons Mode Button – Use to switch the window from the “Call Handler” mode to the “Buttons” mode.

Buttons Mode

Below is a sample view of the side window screen in Buttons mode, which provides 12 user-programmable buttons for the user.



- Dock button – Use to dock the window back to the main screen (if detached) or hide inside the main screen (if attached.)
- Close button – Use to close the side window.
- User Programmable Buttons – A number of keys can be easily configured by the user as “Feature” keys, “Speed Dial” keys, “Call” keys, “User Action” keys, etc. For programming details see “User Programmable Keys” on page 22.
- Resize Points – Click and drag to resize the side window. The buttons will automatically rearrange to the shape of the window. Small sizes cause some buttons to hide.
- Call Handler Button – Use to switch the window from “Buttons” mode to the “Call Handler” mode.

Companion Application Windows

Companion Application Windows open as the result of clicking one of the Option Keys on Net Phone. These windows open docked (connected) to the bottom side of the main window or can be undocked (moved away) from the main window. While a companion window is docked with the main window, whenever the main window is moved the companion window will move with it. And likewise whenever the main window is minimized (into the system tray) or restored, the companion window(s) moves with it.

When companion windows are undocked, they float separately from the main window and can be moved and resized separately.

The More Buttons companion application provides an optional capability allowing the window to dock to either the left or right side of the screen. The buttons change configuration to show in a single vertical column and remain in view with other applications open on the desktop.

Skins

Skins provide the method for changing the color scheme and button appearance. Skins can affect the following elements of Net Phone:

- Screen colors, texture, rounding, and appearance.
- LCD colors
- Calls window size.
- Programmable Button shapes and colors
- Dial Pad button shape and colors
- Graphic on the main screen

To Change Skin Selection

Right-click your mouse on the logo on the main window.



- Select one of the “Skins” from the Phone Colors menu or choose the <Skin Designer> to create a new design. Note: When you design a new “Skin” and save it as a new file name, this change will not appear in the Phone Colors menu until the next time you restart Net Phone.

This section defines settings that are available to the user for customizing Net Phone to meet their needs. A number of additional settings are available for the System Administrator for setting more advanced features such as controlling access to some features, creating a server-based rules and configurations. This section will concentrate on the settings readily available to the user.

These settings are arranged into Preferences, Hot Keys, Option Buttons, User Programmable Buttons, and User Defined Actions. Each of these sections will define the settings and how to change these settings to match your needs.

Preferences

Setup Preferences has a number of settings for making Net Phone work and look the way you choose. To access Setup Preferences click on then select Setup > Preferences. The settings in Preferences are divided between four tabs each defined below.

Note: Depending on your configuration you may not be able to change the Preferences, in which case you should check with your System Administrator.

General Tab

These settings control how Net Phone interacts with other Windows-based programs and how it should react when calls ring or are being dialed. Extra Call Information can be enabled and content to be displayed defined as well as details for Microsoft Outlook Integration when used.

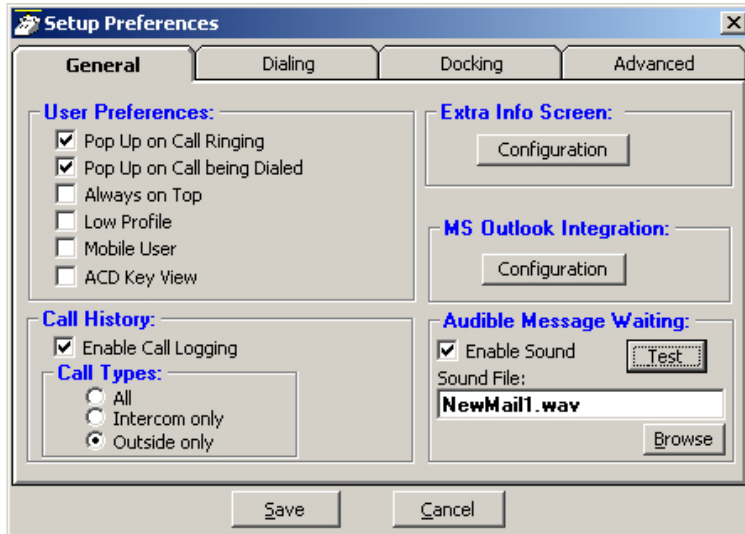

User Preferences

- Pop Up on Call Ringing – Check this option if you'd like your Net Phone to automatically pop up when a call rings on your phone.
- Pop Up on Call being Dialed – Check this option if you'd like your Net Phone to automatically pop up whenever a call is being dialed from another program (via TAPI or DDE dialing) or dialed via Hot Key dialing.
- Always on Top – Use this option to keep Net Phone on top of all other programs. This makes it easily accessible.
- Low Profile – Enabling this option makes the Net Phone very thin in the “Streamlined Mode” by eliminating the Option Buttons on the bottom of the screen.

- **Mobile User** – some users travel with a laptop PC from desktop to desktop each time using the Net Phone with a different PBX extension. This Mobile User option will pop up a “Login” screen each time Net Phone is started so that they can log into the appropriate PBX phone extension.
- **ACD Key View** – This option changes the keys on the left side of the main Net Phone screen to wide keys, which can then be programmed to ACD functions, like login/logout, ACD status, etc.

Call History

- **Enable Call Logging** – To have Net Phone collect and display Call History, Call Logging must be enabled.
- **Call Types** – Once Call Logging is enabled, a choice needs to be made to log All, Intercom Only, or Outside Only calls.

Audible Message Waiting

An audible sound can be played when the Message Waiting indication turns on. The sound played can be any .WAV file of your choosing.

- **Enable Sound** – Placing a check mark in the box enables playing a sound in the file shown. Clicking the Test button will allow you to listen to the sound selected.
- **Sound File** – Enter the path to the .WAV file to be played. Use the Browse button when needed to search for the path to the sound file.

Extra Info Screen

Each call may have additional information attached to the call that may be useful. With the Extra Info Feature enabled, this symbol appears with each call. When the symbol is gray, no information is present, when cyan, information is attached and when red, high priority information is available.

The Configuration button in the window accesses the screen for enabling this feature as well as choosing the extra information items to be displayed along with their properties shown below:

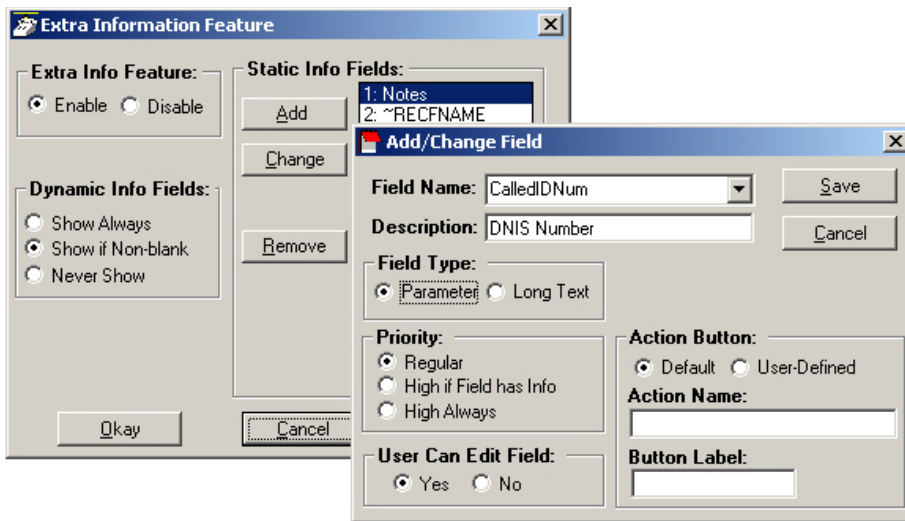

- Extra Info Feature – Provides for enabling or disabling this feature. When disabled, the Call Information icon will not appear with each call.
- Static Information Fields – These fields will have a fixed area within the Call Notes window for the information to be displayed. You have the ability to Add, Change an existing or Remove any field.

► To Add or Change a Static Info Field:

- **Field Name** – Select from the pre-defined list of fields or create you own field name. This name must match exactly the information field where the information is held.
- **Description** – Enter any description you desire to mark this field.
- **Field Type** – Each field can be selected to be either a fixed parameter (1 line) or long text (multiple lines) fields.
- **Priority** – The field priority selected will mark the color of the icon attached to the call.
- **User Can Edit Field** – This determines if this field can be changed or fixed.
- **Action Button** – A button can be defined to use trigger user defined Action. The Action Name must match exactly the name of the Action defined in User Defined Actions.
- **Dynamic Info Fields** – Allows the choice of when these fields will show. provides a large set of fields, which are automatically filled in based upon the call information. Dynamic fields are fields set by another application and are not pre-defined in .

MS Outlook Integration

Net Phone is specifically designed to work in harmony with Microsoft's Outlook contact management program.

- Initial Setup – Click the Configuration button to reach the Outlook Preferences screen with the following options:

Outlook Preferences

Enable Outlook Integration

Dialing:

Home Area Code:

On Manual Dialing -- Lookup in Outlook

Automatically Open a CONTACT for each Call

Add New Contact if No Match Found

Automatically Open a JOURNAL for each Call

Automatically View the Contact's Web Page

Incoming Screen-Pop:

NOTE: Use the Personal Call Handler feature to perform Outlook Screen Pops!

Calendar:

Enable Events from Outlook Appointments Calendar

NOTE: Use the Personal Call Handler to perform Actions when these events occur.

OutLook Phone Link:

- Enable Outlook Integration – This main option enables/disables the Outlook Integration features. This must be checked for any Outlook features to work. If you're not using Outlook, then this should be disabled.
- Home Area Code – Enter your home area code. This is used for dialing local calls when the area code needs to be stripped from the dialing.
- On Manual Dialing – Lookup In Outlook – When enabled, whenever you dial a phone number manually, the phone number will be looked up in Outlook to see if there is a match. If there is an exact match (only one Contact entry matches) the name and account number from the Contact will be automatically attached to the call. Typically this should always be enabled.

- **Automatically Open a CONTACT for each Call** – When enabled, whenever you dial a phone number that matches an Outlook Contact, that contact will be popped only – sometimes referred to as "Reverse Screen-Pop".
- **Add New Contact if No Match Found** – When enabled, if no contact matches this phone number, a "New" contact in Outlook will automatically pop up.
- **Automatically Open a JOURNAL for each Call** – Using Outlook Journal entry makes it convenient to keep track of phone calls made (or received) and to take notes while on a call. By enabling this option a New Journal entry will be popped open whenever you make a call. Also, if the phone number exactly matches an Outlook Contact, then this new Journal entry will be automatically "associated" with that Contact.
- **Automatically View the Contact's Web Page** – When enabled, if the contact record contains a Web address for the caller, this web page will pop up within the browser.
- **Calendar** – Enable appointment and reminder events from Outlook Calendar.
- **Outlook Phone Link** – With the Outlook Link application installed, click the Setup button to access the Setup Configuration for Outlook Link. For details on setting up Outlook Link see the Application Note "Screen Pop Outlook".

Dialing Tab

The biggest choice to make in this tab is to determine whether to follow a Server-based dial plan, use a dial plan defined for your station, or dial all the codes yourself. The last option is not practical when using a database or using “hot key” dialing since other applications never know what is a valid number to dial including entering a trunk access code when needed. If your System Administrator has set up the Server-based Dial Plan, this is the best choice and will save you a lot of time.

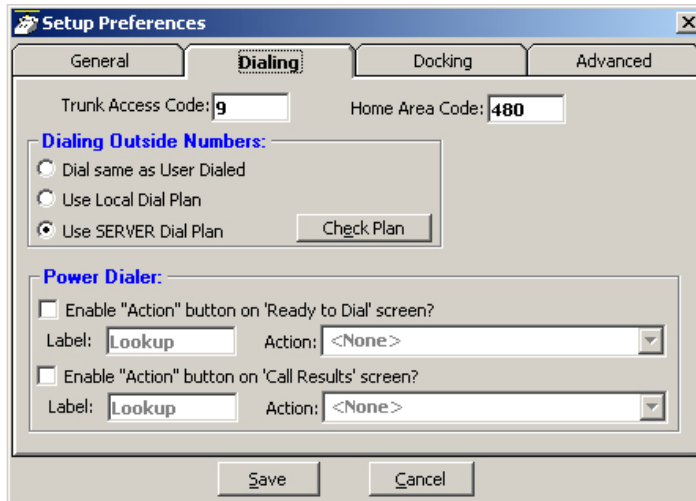

Local Dialing Plan

- Trunk Access Code – This must be set to the access code you need to dial to get an outside line or trunk. Making outside calls using "Speed Dial" keys or dialing from another program, a Trunk Access Code will automatically be dialed to access a trunk before dialing the phone number.
- Home Area Code – Your local area code should be defined here. This is used only when you choose to use the Local Dial Plan.

Dialing Outside Numbers

- Dial same as User Dialed – With this option selected, outside phone numbers will be dialed exactly how the user dialed them (unchanged by Net Phone).
- Use Local Dial Plan – When this option is selected, the user dials an outside phone number, the number will be analyzed according the dial plan and the number will be automatically modified (add "1+" for Long distance, etc) before Net Phone dials it. Use the Change Plan button to view and/or change the settings of the dial plan.
- Use SERVER Dial Plan – When this option is selected, the dial plan that is configured on the NET Server will be used as the dial plan. You can press the Check Plan button to bring up the Server Dial Plan Tester screen that allows you to enter a Test Phone Number and see how it will be dialed. It is the responsibility of the System Administrator to setup and maintain the server dial plan.

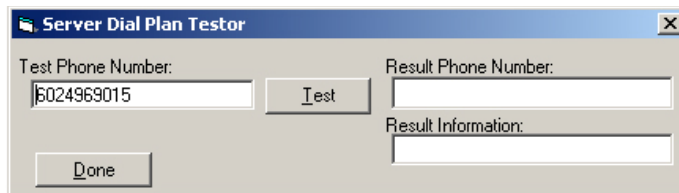

Power Dialer

When the Power Dialer option is installed, two action buttons can be defined for use with the Power Dialer. These user-defined buttons can appear on both the Ready to Dial and the Results screens used with the Power Dialer. Please see the “Power Dialer Administrator’s Guide” for details.

- Ready to Dial – Enable the Action button and select the Action to be performed when the button is pressed. Optionally, the label can be changed to meet your needs.
- Call Results – Enable the Action button and select the Action to be performed when the button is pressed. Optionally, the label can be changed to meet your needs.

Defining a Local Dialing Plan

Each area of the US uses a different set of rules for determining which calls are local calls or long distance. For your area, a good source for determining how to define your dialing plan, use the opening pages of your phone book. These pages generally define how to dial different areas and provide a listing of prefix codes for the local calling areas. Three typical examples are:

1. Phoenix, AZ – all calls within the "602", "480", and "623" area codes are considered to be local calls, while all calls outside those area codes are considered long distance.
2. Santa Fe, NM – calls to some office codes within the "505" area code are considered to be local calls, while other calls to the "505" area code are considered long distance.
3. Atlanta, GA – all calls to area codes "770" are considered to be local calls while some calls to the "404" and "678" area codes are also considered to be local calls.

If you chose to use the Local Dialing Plan, you need to create a dialing plan. If you chose SERVER Dial Plan, then you should check with your System Administrator if you have questions.

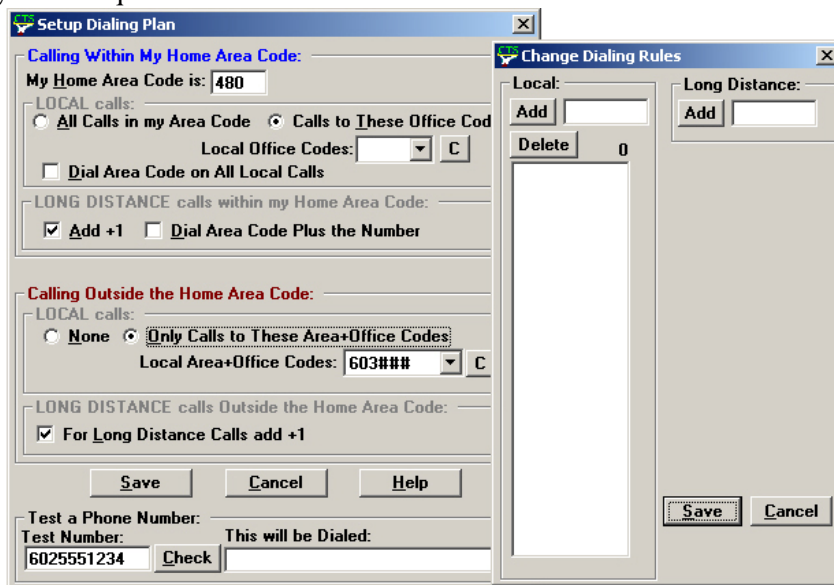

Calling Within My Home Area Code

- Home Area Code – Set this to the Area code where the phone is located. This will be used by Net Phone to determine which dialed calls are within your home area code and when searching a contact manager (reverse screen-pop) the dialed number will need the area code included, i.e. Microsoft Outlook. This is a duplicate of the entry to the one made in the Dialing Tab, thus the value entered previously will show here.
- All Home Area Code Numbers Local? – Select either All Calls in my Area Code or only Calls to these Office Codes.
- Local Office Codes – This entry is only presented if you chose Call to these Office Codes in the previous step. The pull down listing shows the exchange codes (prefix codes) that are considered to be a local call from your location. Click the C button to display the "Change Dial Rules" screen.
 - To Add Local Prefix Codes – Enter the prefix code and click Add. The wild card character '#' can be entered at the end of a prefix code entry to represent a range of codes. For example, 75# would represent all codes 750 to 759 and 7## would represent codes 700 to 799.
 - To Delete Local Prefix Codes – Highlight a prefix entry and click Delete button. The delete button removes the entire entry from the list, thus if the entry has a wild card, then it removes all codes represented by the wild card character.
 - To Delete a Specific Prefix Code – To delete one prefix code that is part of a range of codes entered using a wild card character, enter the prefix code to be considered not local in the Long Distance box and click Add. For example, if prefix code 755 is long distance but all other 75# codes are local, first enter 75# into the local list and the add 755 as Long Distance – the resulting local list will be 750, 751, 752, 753, 754, 756, 757, 758 and 759.
- Dial Area Code on Local Calls – Enable this feature in areas, such as Atlanta, where you must always dial the full 10-digit phone number (include the area code) even when the call is local. Most areas of the US, local calls do not include the area code and dial only 7 digit numbers for local calls. Any number dialed from another program or hot key dialing will be down to its base 7 digits by removing the Home Area Code before it is dialed.
- Add+1 – Check the box if you need to dial a leading 1 before the number for calls within your Home Area Code.
- Dial Area Code Plus the Number – Check the box when the home area code is also to be dialed.

Calling Outside My Home Area Code

- Any calls outside your Home Area Code LOCAL calls? – Select either None or Only Calls to These Area+Office Codes.
- Local Area+Office Codes – This entry is only presented when you chose Only Call to These Area+Office Codes in the previous step. The pull down listing shows the codes (area code plus prefix codes) that are considered to be a local call from your location. Click the C button to display the "Change Dial Rules" screen.
 - To Add Local Area+Prefix Codes – Enter the six digit area+prefix code and click Add. The wild card character '#' can be entered at the end of a prefix code entry to represent a range of codes. For example, 602### would represent all prefix codes in area code 602.
 - To Delete Local Area+Prefix Codes – Highlight a prefix entry and click Delete button. The delete button removes the entire entry from the list, thus if the entry has a wild card, then it removes all codes represented by the wild card.
 - To Delete a Specific Area+Prefix Code – To delete one prefix code that is part of a range of codes entered using a wild card character, enter the prefix code to be considered not local in the Long Distance box and click Add.
- For Long Distance Calls add +1 – Check the box when you need to have a leading one ("1") added when making long distance calls outside your home area code.

Test a Phone Number

Dialing plans can become complex. Use these boxes to enter different telephone numbers and check to see the number that will be dialed. The dialed number should be identical to what you need to dial when using your phone.

Docking Tab

The docking tab defines the contents of Net Phone when docked to the top or bottom of the screen. This includes whether docking is enabled or disabled, uses the slim or regular profile and a listing of contents by display priority (space limits what can be displayed).

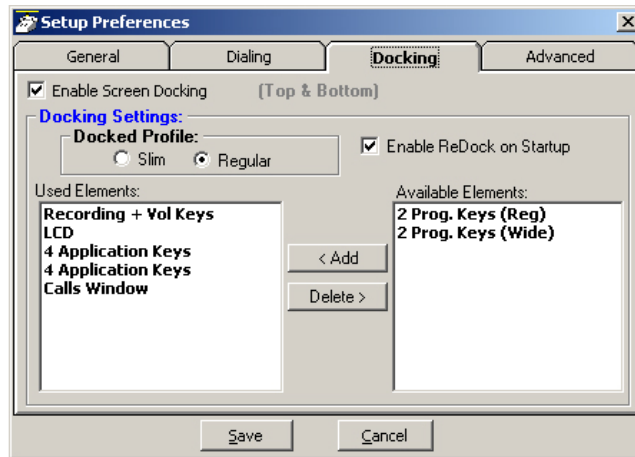

- Enable Screen Docking – When enabled, the Net Phone will automatically ‘dock’ to the top or bottom of the PC screen when it is moved to the top or bottom.

Docking Settings

- Docked Profile – Once screen-docked the Net Phone will take on either a Slim or a Regular profile selected here.
- Enable ReDock on Startup – Place a check in the box to cause Net Phone to startup in the same position and condition as when it was last shut down.
- Used Elements – The displays, buttons, etc. to be used in each profile are configured by moving available elements to the “Used Elements” list. Whenever the Net Phone is screen docked, it will place the elements from the “Used Elements” list on its screen starting from the top of the list, using as many elements as possible until it runs out of space on the right side of the PC screen. Some types of elements can only be used once (like an “LCD”) whereas other elements (like “Programmable Keys”) can be used numerous times.
- Available Elements – The “Available Elements” list shows the types of elements that are available for use in this profile. Note: Once you’ve changed the screen-docking settings, the new settings will not be used until the Net Phone is ‘undocked’ (if it’s already screen-docked) and then re-docked.

Advanced Tab

This screen allows the changing of the basic connection for Net Phone and provides for the ability to send log files to Technical Support for debugging problems encountered in the field. The TAPI Service Provider should not be changed unless your System Administrator has instructed you to update the settings for finding Net Server for your application.

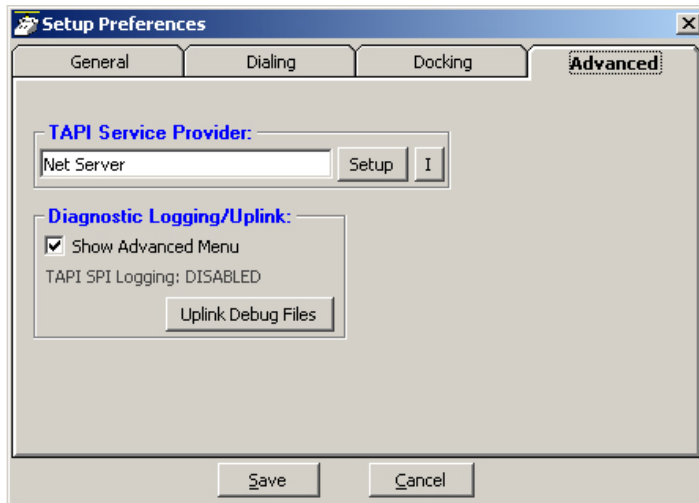

TAPI Service Provider

- Enter the Service Provider Name – This must be set to access the TAPI service provider to be used – typically, this would be set to: Net Server.
- Setup – Clicking the Setup button opens a screen to define the TAPI Service Provider as shown in the diagram below. The I button is a handy status indicator for reading the version levels and license codes for the system and is shown in the TAPI SPI Info screen below.

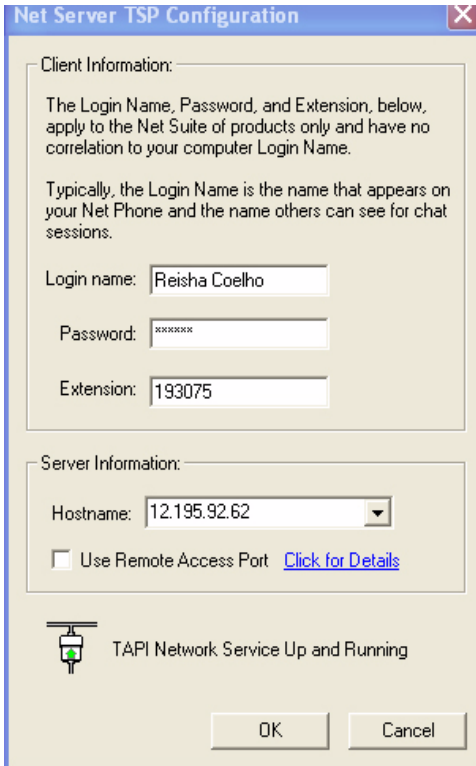

Net Server TSP Configuration

Client Information:

The Login Name, Password, and Extension, below, apply to the Net Suite of products only and have no correlation to your computer Login Name.

Typically, the Login Name is the name that appears on your Net Phone and the name others can see for chat sessions.

Login name:

Password:

Extension:

Server Information:

Hostname:

Use Remote Access Port [Click for Details](#)

 TAPI Network Service Up and Running

OK Cancel

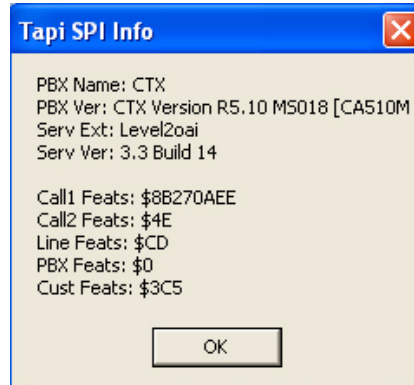

Tapi SPI Info

PBX Name: CTX
PBX Ver: CTX Version R5.10 M5018 [CA510M
Serv Ext: Level2oai
Serv Ver: 3.3 Build 14

Call1 Feats: \$8B270AEE
Call2 Feats: \$4E
Line Feats: \$CD
PBX Feats: \$0
Cust Feats: \$3C5

OK

- Login name – Enter your Login name. If a new installation, a client will automatically be created in Net Server for this name. Many times the administrator will have defined your client Login name, see your administrator for the name to use.
- Password – Enter an optional password for protecting the connection, when needed.
- Extension – Enter the extension number of the phone this Net Phone is monitoring for call information.
- Hostname – Enter the name of the Server PC where Net Server resides.
- Use Remote Access Port – Check this box only when connecting remotely through the Internet. When connected locally through your LAN, do not check this box.

Diagnostic Logging/Uplink

This section allows enabling of the Debug utility and have it show on the Main Menu under Settings as well as provide an easy utility for sending all the important information about Net Phone to assist Technical Support to help diagnose any problems when necessary.

- **Show Advanced Menu** – Place a check in the box to enable the Main Menu > Settings > Advanced menu option. This needs to be enabled to capture events or show call information when Net Phone is operating. Note: The statement “TAPI SPI Logging: DISABLED” is the normal indication and is provided to show Tech Support of the status of this device. Tech Support will provide specific instructions for turning on this setting.
- **Uplink Debug Files Button** – Click this button to access the screen for creating a site name, a contact for the file transfer, and the changing of any options for reporting a problem.
- **Site Name** – Before using the Uplink Debug Files button, a site name and contact must to be selected. The site name is a unique identifier to make it easier to find the log files for your site and typically, the contact should be assigned “Any Tech Support” to ensure the log files are seen by someone. Use a specific contact name once you are working with an agent and they request you send the “Zip Log Files” to them.
- **Description** – It is highly recommended to write a description of the problem including all pertinent details such as the conditions and approximate time the incident occurred. These descriptions aid in narrowing down where to look in the log files for the problem encountered.
- **Options** – Clicking the Options button opens a screen to provide options for how the files are to be sent. The default and recommended option is to “Send Directly to FTP Site”. As an option, when direct Internet access is not available from that PC, the files can be zipped into smaller files, saved on your PC in your Local Settings folder, typically “Ö\Documents and Settings\jgreen\Local Settings\Application Data\CTS\NetPhone\Zip”. These files can then be e-mailed to .

Setting Up Hot Key Dialing & Popup

Net Phone provides two global “Hot Keys” that you can press within any application to send a request to Net Phone. The first key is the Dial Hot Key will provide a method for dialing a number from any application. For example, you may have a phone number in a Microsoft Word document that you can highlight in the Word document and press the hot key combination assigned. This dials the number in Net Phone. By default the Hot Key is F11.

The second key is the Popup Hot Key, which will bring Net Phone to the front on the screen. This can be very useful if the Net Phone is minimized or is behind other windows on your screen. Net Phone must be running for this hot key to work.

Setting Shortcut Keys

Click the main menu icon and then Setup > Shortcut Keys > Hot Key Dialing & Popup to access the settings for defining the “hot keys”:

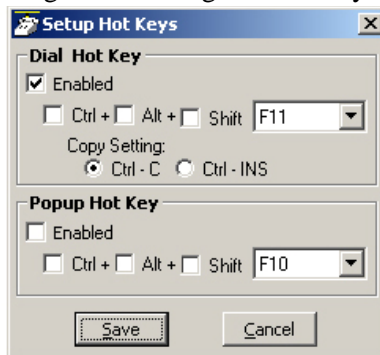

- Dial Hot Key – Enable the hot key button and select the key to use including any modifying keys to be used in combination.
- Popup Hot Key – Enable the hot key button and select the key to use including any modifying keys to be used in combination.

Note Five other Shortcut Keys also appear on the Setup > Shortcut Keys menu. Many applications use various “hot keys” or keyboard shortcuts. These keys are defined in advanced settings that your administrator can change if you encounter a conflict with another application. See “Net Phone System Administration Manual” for details.

Options Buttons

Net Phone provides a powerful architecture that allows companion applications to add features and functions. These companion applications inherit the look-and-feel of Net Phone and act as if they are “part of the Net Phone” and are provided as Options Buttons. These companion applications were provided as choices when Net Phone was installed on your PC.

Up to eight individual buttons may be configured to view on the main window. Your ability to change these may be restricted by the administrator. The companion applications open and dock to the bottom of Net Phone. Users may also detach the companion applications and place them anywhere on the desktop.

Access to Option Buttons applications is also possible using the User-Defined Action, see “Pop Internal Web Browser” on page 30 for details. This action can be placed on any Programmable key to expand the number of Option Buttons available or the action can be used in the Personal Call Handler to automatically open an application based upon certain call triggers.

► To Copy this Button onto Another Button

1. Right-click on the Option Button to copy.
2. Click the Option Button to receive the copy.

► To Swap Two Buttons

1. Right-click on the first Option Button in the swap.
2. Click the second Option Button to complete the swap.

► To Change Button

- Right-click on the Option Button to change.
 - Key Type – Select a type of companion application from the pull down listing. See the Button types that follow for specifics for each one.
 - Key Label – The label will default for the Key Type selected, change the label, if needed.
 - Tool tip – This entry will appear in the “bubble” when the mouse hovers over this button.
 - Save Setting – Click the Okay button to save the setting or Cancel to exit without saving.

Option Button Key Types

Directory Button

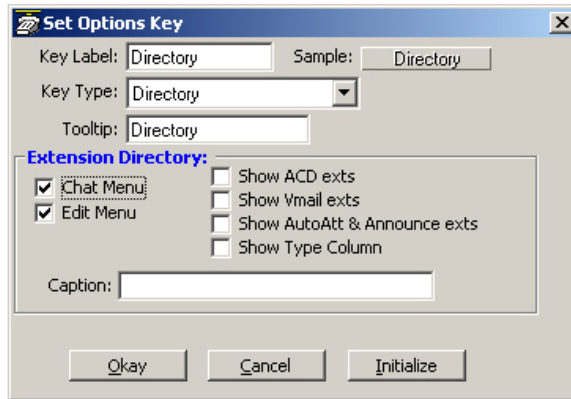

Extension Directory

- Chat Menu – Enables right-click access to Chat another user from the Directory window.
- Edit Menu – Enables right-click access to the Edit menu for Directory listings.
- Show ACD Exts – Hunt Group/ACD Group extensions will appear in the Directory listing.
- Show Vmail Exts – Voice Mail extensions will appear in the Directory listing.
- Show AutoAtt & Announce Exts – Application extensions will appear in the Directory listing.
- Show Type Column – The Extension Type column will appear in the Directory listing. N = Name, H = Hunt Group, A = Application, etc.
- Caption – Enter a name to be displayed in the window to distinguish this directory listing from other directory listings.

Feature Directory Button

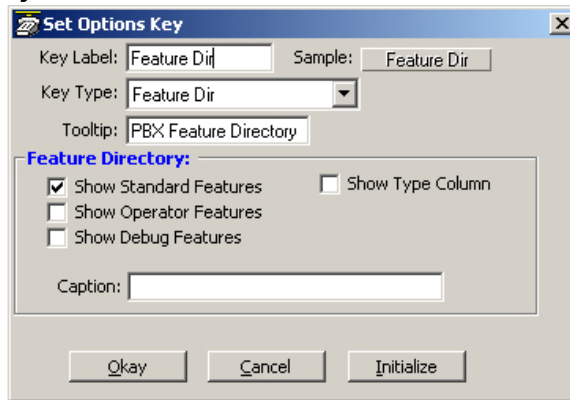

Feature Directory

- Show Standard Features – Display standard PBX feature codes in the Directory listing.
- Show Operator Features – Display Operator feature codes in the Directory listing.
- Show Debug Features – Display Debug features in the Directory listing.
- Show Type Column – The Feature Type column will appear in the Directory listing. S = Standard, O = Operator, D = Debug.
- Caption – Enter a name to be displayed in the window to distinguish this directory listing from other directory listings.

Speed Dial Button

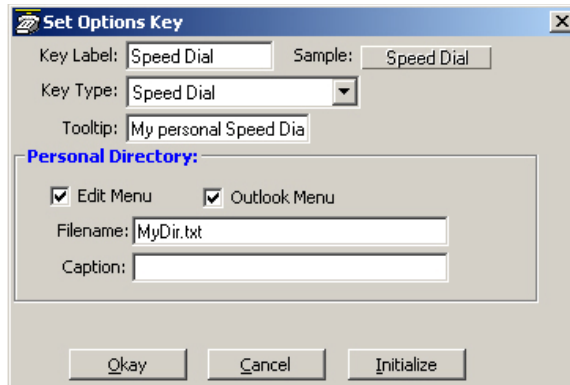

Personal Directory

- Edit Menu – Allow right-click access to edit records in the Personal Directory.
- Outlook Menu – Allow right-click access to Outlook features in the Personal Directory.
- Filename – File to store the personal Speed Dial records.
- Caption – Enter a name to be displayed in the window to distinguish this directory listing from other directory listings.

Call History Button

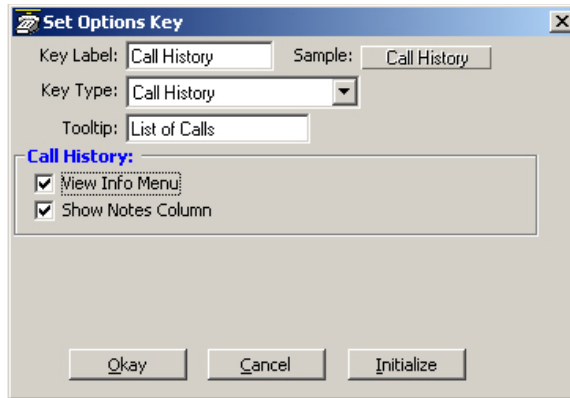

The screenshot shows the 'Set Options Key' dialog box with the following settings:

- Key Label: Call History
- Sample: Call History
- Key Type: Call History
- Tooltip: List of Calls
- Call History:**
 - View Info Menu
 - Show Notes Column

Buttons at the bottom: Okay, Cancel, Initialize.

Call History

- View Info Menu – Enables the View Info menu in the Call History Window. Right-click a Call Record to access the View Info Menu.
- Show Notes Column – Allows Call History to show the Notes field for each Call Record.

More Buttons

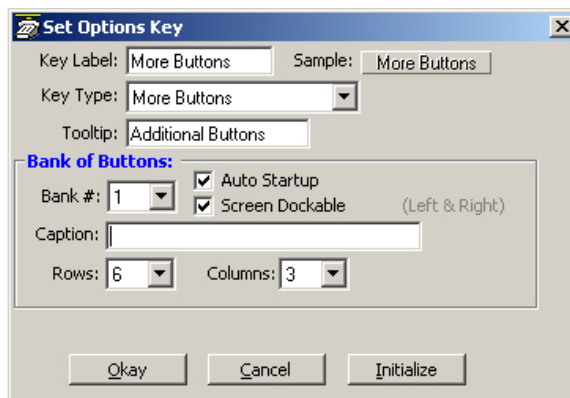

The screenshot shows the 'Set Options Key' dialog box with the following settings:

- Key Label: More Buttons
- Sample: More Buttons
- Key Type: More Buttons
- Tooltip: Additional Buttons
- Bank of Buttons:**
 - Bank #: 1
 - Auto Startup
 - Screen Dockable (Left & Right)
 - Caption:
 - Rows: 6
 - Columns: 3

Buttons at the bottom: Okay, Cancel, Initialize.

Bank of Buttons

- **Bank #** – Specifies the group number of the button bank. You must specify a unique number for each bank of buttons. If you assign the same bank to more than one button, each of those buttons will show the same bank of keys.
- **Caption** – Enter text to appear as a “title bar” for the new button bank.
- **Rows** – Defines the number of rows of keys on the button bank.
- **Columns** – Defines the number of columns of keys on the button bank.
- **Auto Startup** – Place a checkmark in the box to automatically open this bank of buttons whenever Net Phone starts up.
- **Screen Dockable** – Place a checkmark in the box if you want this bank of buttons to be capable of docking to the left or right side of your screen.

Browser Button

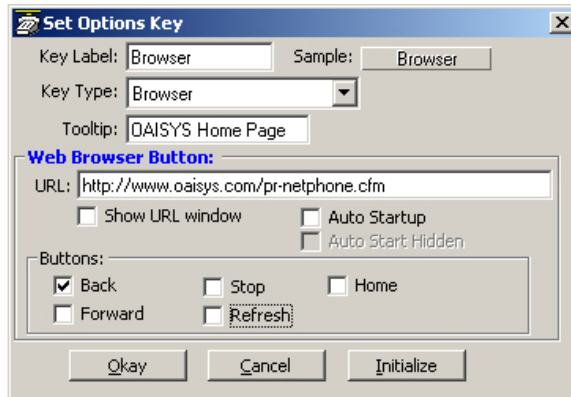

Web Browser Button

- **URL** – Enter the URL to act as the Home Page with the Net Phone Browser window.
- **Show URL Window** – Display the URL text box, allowing you to enter new URLs while browsing.

Net Phone Settings

Options Buttons

- Auto Startup – Allow the Browser to start automatically with Net Phone. Useful for screen pop or data access applications.
- Auto Start Hidden – When used with Auto Startup, it opens a web page, but the Browser window remains hidden.
- Buttons – Place a checkmark in the box next to the Browser controls to show in the Browser window.

Chat Button

An integrated text-messaging function that allows you communicate with other Net Phone users using text messaging ‘calls’ even while you’re busy on the phone. See the Chat Administrator’s Manual for more details.

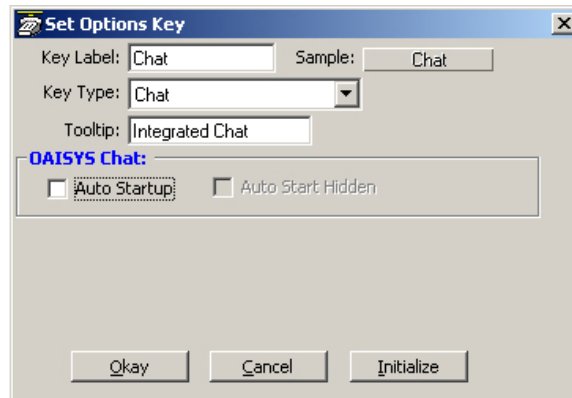

Chat

- Auto Startup – When enabled, Chat will startup when Net Phone starts. This provides your “on-line” status to all other Chat users. The Chat dialog box will also open.
- Auto Start Hidden – This mode allows Chat to be active, providing status to other Chat users, that you are ‘on-line’, but the Chat dialog box will not display until someone calls you or you press the button to make a call using Chat.

Power Dial Button

Allow you to automatically call a list of phone numbers or dial phone numbers at specified dates and times. See the Power Dialer Administrator Manual for details.

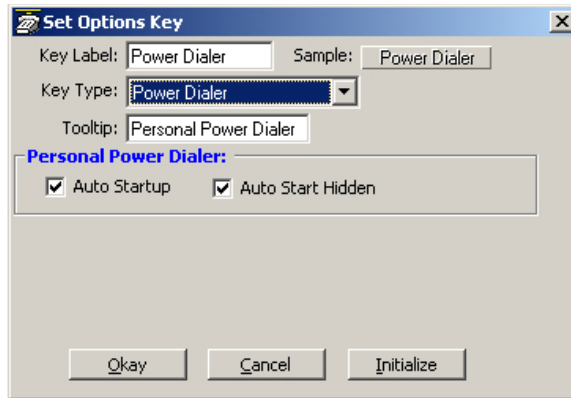

Personal Power Dialer

- Auto Startup – When enabled, Power Dialer will startup when Net Phone starts. The Power Dialer dialog box will also open. With the Power Dialer started, scheduled calls can function as planned.
- Auto Start Hidden – This mode allows the Power Dialer to be active, but the Chat dialog box will not display.

Replay Button

Replay is a client application for OAISYS Tracer. Replay must be installed on this PC to access call history and recorded files from Tracer. See the OAISYS Replay Administrator's Manual for details.

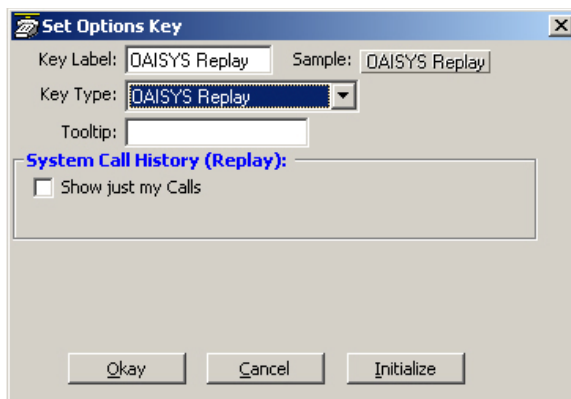

System Call History (Replay)

- Show just my Calls – If the permissions for Replay allow more than just your calls, this option can limit those viewed using this Option button will be filtered to “my Calls” only.

User Programmable Keys

The Net Phone has many different User Programmable keys on the main screen, on the Side Window, or on the Extra Button windows. These keys can be easily configured by the user as "Feature" keys, "Speed Dial" keys, "User Action" keys, "DSS" keys, "Web Access" keys, "Run another Application" keys, or "ACD" keys, etc. This provides the user with one-touch access to features, applications, files, phone numbers, employees, and more. To change any of these keys simply right-click the mouse over the key and select from the menu one of the following options:

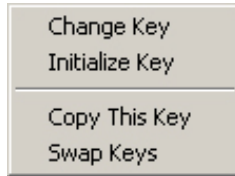

To Initialize Key

This resets the key to a blank default state. This makes it much easier to use the drag and drop techniques for setting up keys.

To Swap Keys

To swap the configuration of two programmable keys you can simply drag & drop one to the other. To do this, hold the Ctrl key down while using the left mouse button to drag a key to another location. Or select Swap Keys and then drag & drop key to new location. Keys will swap within the same window and between the Side window and the Main Screen. Keys on the Main Screen or the Side window will not swap with keys on the Extra Buttons windows or vice versa.

To Copy This Key

To Copy the configuration of one programmable key to another hold the keyboard Ctrl and Shift keys down while using the left mouse button to drag the key to be copied to its target. Or select Copy This Key and then drag & drop to new location. Keys will copy within the same window and between the Side window and the Main Screen. Keys on the Main Screen or the Side window will not copy to keys on the Extra Buttons windows or vice versa.

To Change Key

This opens the Setup Key configuration settings shown below. Several items in the upper portion of this window define the appearance and label of the button. Selecting an Action from the pull down listing will present additional parameters needed to define the choice. Details for each Action follow this procedure. Note: Some users may not have permission to change buttons and keys.

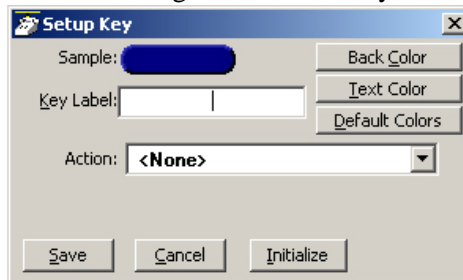

- Sample – Displays the appearance of the following selections.
- Key Label – Type a label for the key.
- Back Color – Choose the color of the key.
- Text Color – Choose the text color to use for the key label.
- Default Colors – Pressing this button will reset the colors of the key and text to the default for the skin used.
- Action – Choose an action to be performed. This selection will open additional settings corresponding to that action. See the settings below for the different possible actions.

Feature Code Keys

Provides one-button access to a Feature Code on the PBX. You can include additional digits when appropriate. The PBX used will determine access to the Feature Codes available. For example, to log into ACD Group x2000, you could set the Parameter to “326 2000” to work as a Log In key.

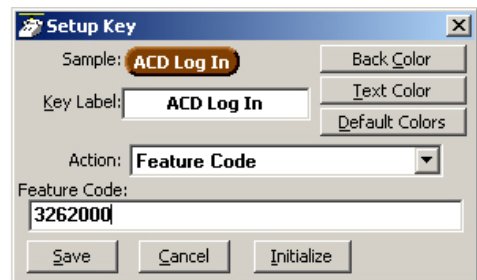

Speed Dial Keys

Creates a speed dial key for one-button dialing. Net Phone automatically inserts the Trunk Access Code when a Dial Plan has been specified, making it unnecessary to enter this code in the speed dial number. Speed Dial numbers can be any number 0~9 and * and # digits. You can include commas to insert a 2-second pause in the dial string, i.e., setting up a key to call V-mail (x2502) and logon to a mailbox (1000 with password 12345) then enter "2502, *1000,12345".

You can also include an "X" character in a phone number string to have the dialing stop at that point and queue up the rest of the number in the dial buffer. The user can listen to the call and click the Dial button to dial the rest of the digits at the appropriate time. Examples include: (1) dialing a person who has an extension number (i.e. "4969040 x1008"), (2) dialing a pager and you want to display a number on the LCD of the pager (i.e. "5551234x4969040#"), or (3) dialing a long distance access code (i.e. "8884083279 x17135551234"). Note: You can use more than one "X" in the phone number and it will wait after each "X" (i.e. "4969040 x8 x*1009,1234").

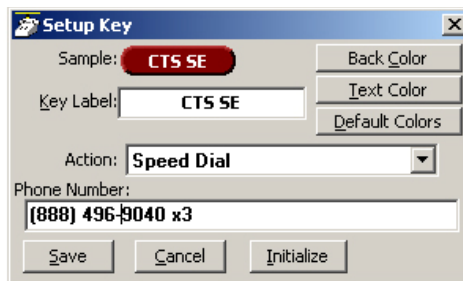

System/PBX Command Keys

The System/PBX command keys are maintained for backward compatibility. It is highly recommended that the user create User Defined Actions for System/PBX Commands. The User Defined Actions have expanded the options available for a number of these commands and thus offer better choices.

The description below shows the possible features that appear in the Setup Key window. Some of the features listed are dependant upon Net Phone System Administration settings such as the Auto Call Record/Tracer Recording features, which only appear when the System Administrator enables those items. Others are dependant upon the PBX used by Net Phone.

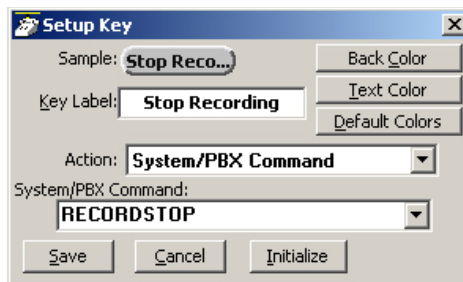

The commands that may be available will depend upon the PBX you are using. Commands that may be available include:

PBX Call Control	Auto Call Record/Tracer Recording
Answer – Current call.	Start Record
Conference – Simulates pushing Conf key.	Stop Record
Dial xxxxxx – xxxx= the number to dial.	Set Bookmark “Msg”
Hangup – Hangup current call.	Call Center
Hold – Hold current call.	ACD – Agent Help
* Modify Call “Field” “Value	ACD – Call Pickup
* Transfer	Set Work Units “Value”

* An enhanced feature is available in User Defined Actions

User Defined Action Keys

Customized features can be placed on keys by using User Defined Actions. Actions that have been defined will be available in the pull down list. To create a new action, go to the User Defined Actions section to create the action before defining the key. If the programmable key is on the Main Screen or the Right side window, an Edit button appears that is a short cut to the User-Defined Actions.

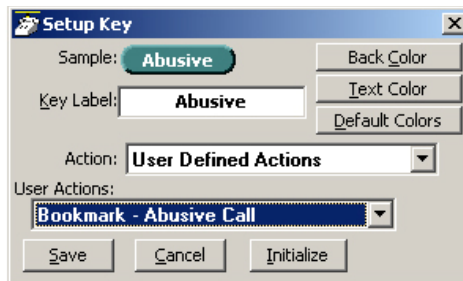

ACD Keys (Main Screen only)

These ACD Keys Actions are only available on the wide keys on the Main Screen (Net Phone must be set to use “ACD Key View” in Preferences). Depending on the configuration of your call center, these keys can be used to: (1) Login or Logout of ACD groups (via Agent ID and phone Extension) and/or (2) to Show/Set your Agent status. Other ACD functions may be available in the User-Defined Actions depending upon the PBX used with Net Phone. Note: The color of ACD Keys cannot be changed as the colors are determined by the ACD State for the key.



DSS Extension Keys

Direct Station Selection provides one-button dialing to a specific station. DSS Keys also provide a visual status indicator of the station: Ringing, Busy, Idle, or Do-Not-Disturb. An easy method for creating DSS keys is to open the Directory and drag and drop names in the Directory onto keys. You can then change the colors and edit the name for easy identification.

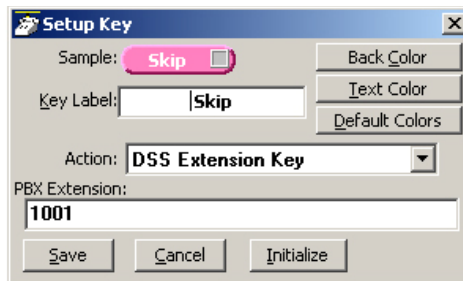

Web Keys

Web keys allow you to program an Internet (or intranet) URL into the key. Press the key to open the default web browser to the specified web page.

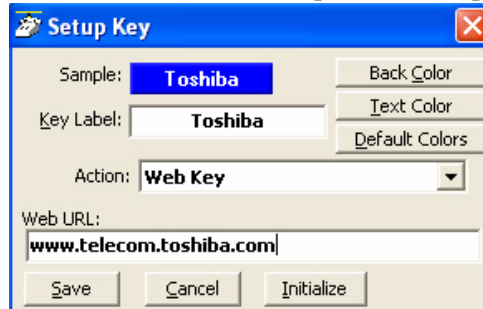

Run Program Keys

This sets the key to run a specific application or load a specific document. For example you could create a “Calculator” key to run the windows calculator by setting the “Program filename” to CALC.EXE. Alternatively you could create a key to show your “projects” Excel spreadsheet by simply setting the “Program or Document Filename” to: PROJECTS.XLS.

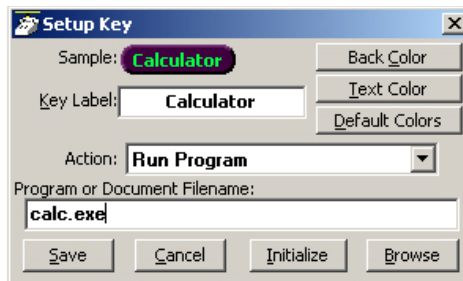

Creating Keys using Drag & Drop

Program unused keys by simply dragging phone numbers or feature codes from other programs. Some examples include:

- Drag a Contact from Microsoft Outlook to a key to create a Speed Dial button
- Drag a call from the Call History to create a Speed Dial button
- Drag an entry from the Personal Speed Dial Directory to create a Speed Dial button
- Drag an entry from the Extension Directory to create a DSS key for that extension.
- Drag an entry from the Feature Directory to create a phone Feature key.

This page is intentionally left blank.

You can define powerful actions that can be used with both the Personal Call Handler and under the Programmable Keys. These actions can be as simple as playing a .WAV file to as powerful as sending a specific DDE message to another programs to "Screen Pop" a database. When defining a new action, it's usually a good idea to test the action to make sure it works correctly. The screens for creating actions also provide a testing facility to make this testing easy.

Note Depending on your configuration you may not be able to change the User-Defined Actions, in which case you should check with your System Administrator.

Creating Actions

The Creating of Actions can be done by going to the Main Menu Icon > Setup > User Defined Actions.



A window pops up showing a listing of currently defined actions and options that you can Add, Copy, Edit/Test or Delete. Pressing the Add, Copy, or Edit/Test buttons

User-Defined Actions

Creating Actions

takes you to a screen for creating or editing an action. The types of actions that can be created are defined below. When actions are copied, created, or edited, those changes are stored in the compiled actions file (NET_PHN.acs). If this file is lost for some reason and Net Phone is restarted, all actions will revert to the individual actions stored in the User's Local Settings Net Phone folder. Thus, it is wise to save new actions by exporting the action for backup (see "Exporting Actions" on page 39 and "Importing Actions" on page 39).

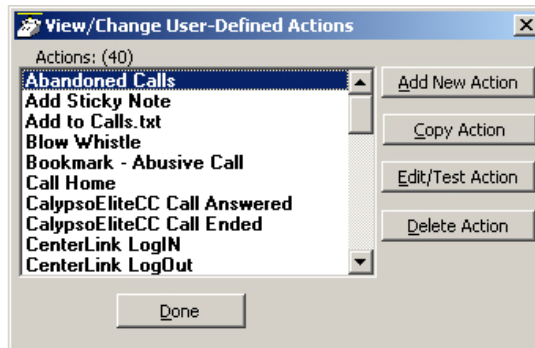

Attach Acct Code

This action attaches an account code to the active call. This account code is passed to other applications such as Insight or TASKE Contact.

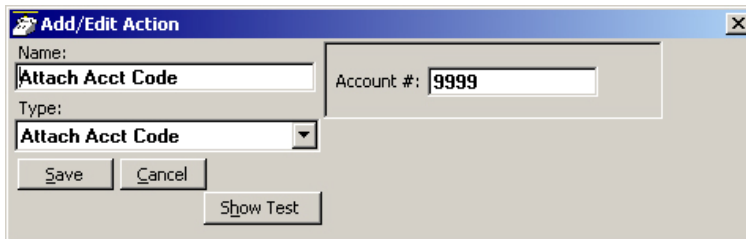

* Account # – Enter an accounting number to be associated with this call.

Export Call Info

This action is used to export call information to another program (like the CTI Call Handler) in order to keep its Call Info Database current. When this action is triggered it will Popup an "Export Call Info" screen allowing the user to fill in any missing call information (typically the 'Main Listed Phone #') before they press SAVE to export the information to the centralized database.

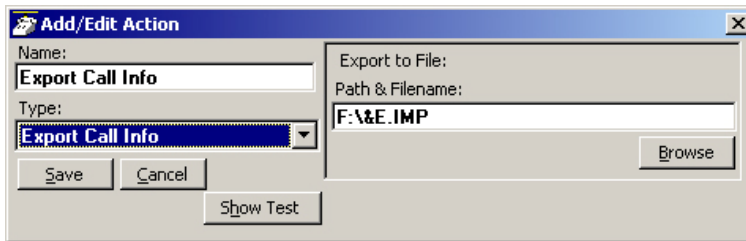

- Path & Filename – Enter the complete path name for writing the exported file or browse to find the path.

Log Info to File

This action writes a string of information to a text file. This can be used to make a call log, like personal SMDR, and/or to trigger actions in other programs. A wide range of call and system variables (see "Action Variables" on page 37) may be used to create the information to be written into the file.

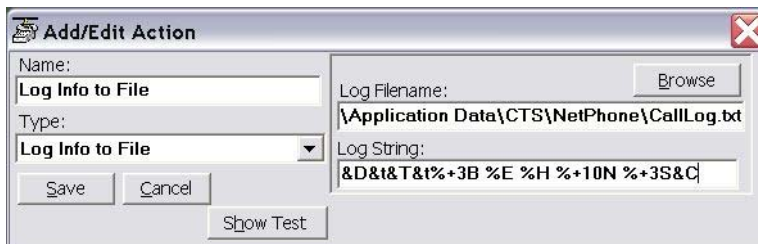

- Log Filename – Enter the complete path name of the file to log the information. Use the Browse button to find the file name, when needed.

User-Defined Actions

Creating Actions

- Log String – Create the string defining the content to be written into the file. The above example created the following entries into the file “CallsLog.txt”. Note: The number of characters sent for the name variable was limited to the first 10 characters (%+10N), which truncated the names in the file to the first 10 characters. See “Action Variables” on page 37 for details.

```
12/02/04 16:27 In 1027 480-496-9040 Joe Blow I No
12/02/04 16:28 In 1027 480-629-8723 Joyce Gree Yes
12/02/04 16:28 In 1027 949-853-3351 Katz Yamag Yes
```

Lookup in Outlook

This action will lookup the phone number in Microsoft Outlook and then selectively opens a contact, creates a new contact, or adds a journal entry.

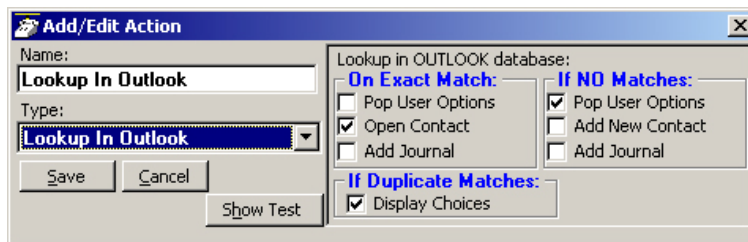

Minimize Phone Screen

This action shrinks the Net Phone screen to an Icon in the Tool Tray. To return Net Phone to its original position requires the user to either double-click the icon in the tray or right-click and select Show.

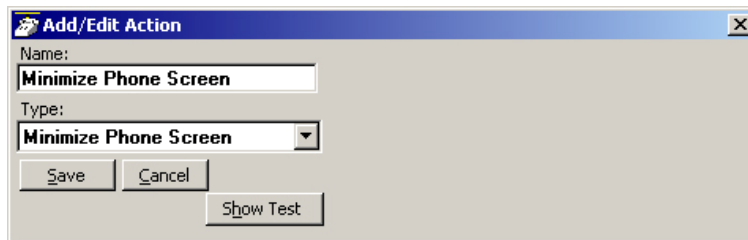

Modify Call Information

This action changes the Caller ID name, Caller ID number, or Account code of the active call on this phone and when the PBX supports the changes, the same information held in the PBX. Using the Extra Info (shown on [page 52](#)) option provides for entering or changing any other information associated with the call.



The screenshot shows a dialog box titled "Add/Edit Action" with a close button in the top right corner. The dialog is divided into two main sections. On the left, there is a "Name:" field containing "Modify Call Information" and a "Type:" dropdown menu also set to "Modify Call Information". Below these are "Save", "Cancel", and "Show Test" buttons. On the right, there is an "Information Type:" section with two radio buttons: "Standard Info" (which is selected) and "Extra Info". Below this are three input fields: "Phone Number:" with the value "9495551212", "Name:" with the value "Toshiba", and "Account #:" which is currently empty.

- Information Type – Select either Standard Info or Extra Info. The Standard Info option supports updating the information in the PBX when supported by the PBX. The Extra Info option can enter or change any field for this call.

Standard Info

- Phone Number – Enter a phone number to be used as the Caller ID number for this call. This replaces an existing number or adds a number, if blank.
- Name – Enter a name for the caller to be used as the Caller ID name. This replaces an existing name or adds a name, if blank.
- Account # – Enter an account code for the call. This replaces an existing number or adds a number, if blank.

Extra Info

The screenshot shows a dialog box titled "Add/Edit Action". It has a "Name" field with the text "Modify Call Information" and a "Type" dropdown menu also set to "Modify Call Information". Below these are "Save" and "Cancel" buttons. To the right, the "Information Type" section has two radio buttons: "Standard Info" (unselected) and "Extra Info" (selected). Below this, the "Field Name" field contains "PREFAGENT" and the "Value" field contains "2007". A "Show Test" button is located at the bottom right of the dialog.

- **Field Name** – Enter the name of the field to be changed. This name must match exactly the field name including uppercase and lowercase syntax. For example, a user may want to create User Programmable Keys identifying the “Preferred Agent” for the call prior to transferring the call into a queue. The Field Name would be entered as PREFAGENT. The value would be the agent’s ID code.
- **Value** – Enter the value to be used for this field. Following the above example, then the agent’s ID code would be entered into this field.

Play WAV File

This action will play a specified WAV file on the PC sound card.



- Path & Filename – Enter the complete path name for the WAV file to be played or browse to find the path of the file.

Pop External Web Browser

This action sends a URL to the PC's default web browser (run the web browser if it isn't already running). Works with Netscape Navigator and Microsoft Internet Explorer.



URL – Enter the complete URL name for the Web site to be opened in your browser. The URL can contain Action Variables to make the lookup use call information.

Pop Internal Web Browser

This action can be used to send a URL to the ‘built-in’ web browser of the Net Phone (when installed) or can be used to create access to other companion application programs.

An example of using your Personal Call Handler to automatically open the Integrated Web Window, whenever an outside call rings in, to provide a script to for answering that call. The URL can contain action variables for example using the DID/DNIS number used for the call to open a page created for each DID/DNIS number. Thus when the call arrives, a screen opens for a script or questions to use for that call.

Another use may be to have several “Personal Directories” where the 8 button limit may not allow access to more directories. Assigning a programmable button can allow opening these personal directories using one-click access.



The screenshot shows a dialog box titled "Add/Edit Action" with a close button (X) in the top right corner. The dialog is divided into two main sections. The left section contains a "Name:" field with the text "Task Home Page", a "Type:" dropdown menu currently set to "Pop Internal Web Browser", and three buttons: "Save", "Cancel", and "Show Test". The right section is titled "Pop Internal Web Browser:" and contains a "Button Name:" field with the text "Browser", a "URL (Param1):" field with the text "www.task.com", and a "Param 2:" field which is currently empty.

- Button Name – Enter the name of an existing Option button (bottom-row buttons on Net Phone). This name must exactly match the name as displayed. This action uses the specified button as the parent window.
- URL (Param1) – Enter a URL or other Param1 parameters as indicated in the table below. The URL can contain Action Variables as part of the entry.
- Param 2 – Optional parameters. See table below for details.

Button Name:	URL (Param1):	Param 2:
Speed Dial	If blank, it uses the default "MyDir.txt" file or enter a file name for your Speed Dial directory.**	<blank>
Directory Note: The default settings when Param 2 is blank has Edit and Outlook menu options enabled and Chat disabled.	If this field is blank, the default file is used based upon the code in Param 2. Param 2 should contain either \P or \F and a file name of your choice with a suffix code of TXT can be used for a private directory. In this latter case enter the file name to be used and create a file following the format of PersonalDir.txt or FeatDir.txt edited for your needs.**	\P – Enable PersonalDir.txt \F – Enable FeatDir.txt (see below for add'l codes) \C – Enable Chat menu option \NC – Disable Chat menu option \E – Enable Edit menu option \NE – Disable Edit menu option \O – Enable Outlook menu option \NO – Disable Outlook menu option \T – Show Type column \+H – Add Hunt Grp/ACD extensions \+V – Add Vmail extensions \+A – Add AutoAttd extensions \-N – Remove normal extensions
Feature Dir Note: A feature directory can be created using Directory when a Feature Dir Option Key does not exist.	If blank, it uses the default "FeatDir.txt" file or enter a file name for your Feature Dial directory.**	\+D – Add Debug features \+O – Add Operator features \-S – Remove standard features \T – Show Type column
Browser	Enter a URL to be opened. If blank, the default URL of the Option key is accessed.	\NB – Do not show Back button \B – Show Back button \F – Show Forward button \W – Show Web URL
Call History	<blank>	\NX – Hide Notes column \NV – Hide View Info option
More Buttons	Enter a number 'n' where n=1~8 representing the button bank to be displayed.	<blank>

User-Defined Actions

Creating Actions

Button Name:	URL (Param1):	Param 2:
Chat	<blank>	<blank>
Power Dialer	<blank>	<blank>
Replay	<blank>	<blank>

Note Specifying a new file name in Param 1 and requires manually creating that file of the same name in the “Documents and Settings\<User Name>\Local Settings\Application Data\CTS\Net Phone” folder may be used. This method allows multiple personal directories to be created, each showing only the names listed in that directory.

Popup Call Info Screen

This action will pop open either the Standard Call Info screen or Extra Call Info screen. The Standard Call Info screen allows the user to type in the Caller ID name or number or Account code of a call, lookup the phone number in Outlook and/or Open a Contact or Journal, or Divert a Ringing call to another location. The either screen allows you to view, change, or attach additional extra information to a call. The fields shown in this window are defined in Preferences, General Tab (see “[Extra Info Screen](#)” on page 16).



The Standard Call Info window is a dialog box with a title bar that reads "Standard Call Info". It contains several input fields: "Phone Number:" with the value "4804969040", "Name:" with "Joe Blow II", "Account #:", "DID Name/#:" with "<none>/<none>", and "FWD/Xfr From:". Below these fields are "Cancel" and "Modify Call" buttons, and a small icon button. A section titled "Outlook" contains "New Contact", "Lookup", and "Add Journal" buttons. At the bottom, there is a "Divert Call" button, a "To:" field, and a "Vmail Box:" field.

Standard Call Information window

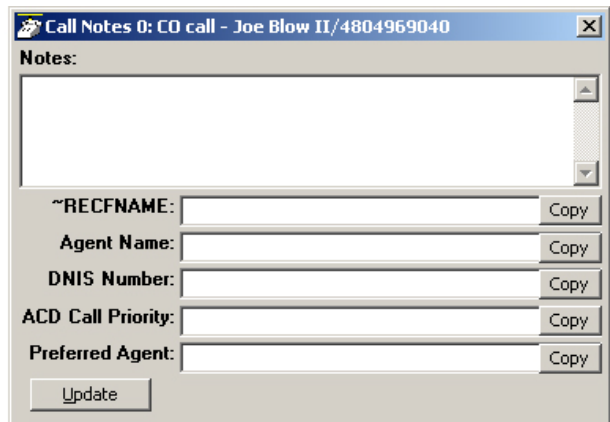

The Extra Call Information window is a dialog box with a title bar that reads "Call Notes 0: CO call - Joe Blow II/4804969040". It features a large "Notes:" text area at the top. Below this are several fields with "Copy" buttons: "~RECFNAME:", "Agent Name:", "DNIS Number:", "ACD Call Priority:", and "Preferred Agent:". An "Update" button is located at the bottom of the window.

Extra Call Information window

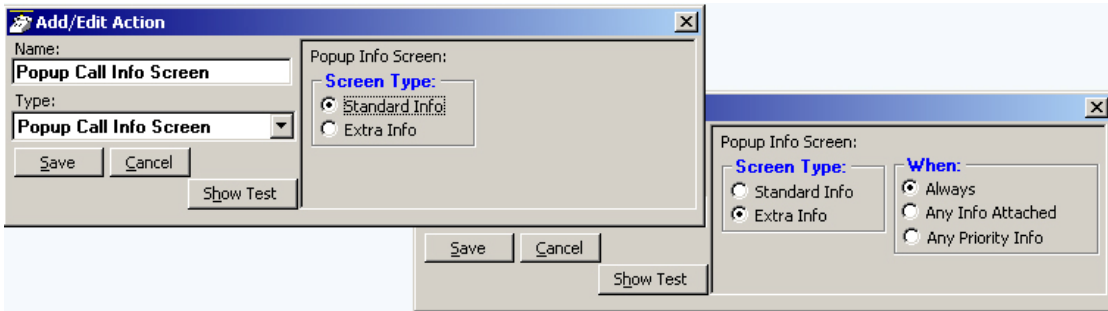

- Popup Info Screen Type – Choose either Standard Info or Extra Info. When Extra Info is selected, choose when the popup will occur: Always, Any Info Attached, or Any Priority Info.

Popup Phone Screen

This action causes a popup (Restore) of the Net Phone screen from an icon.

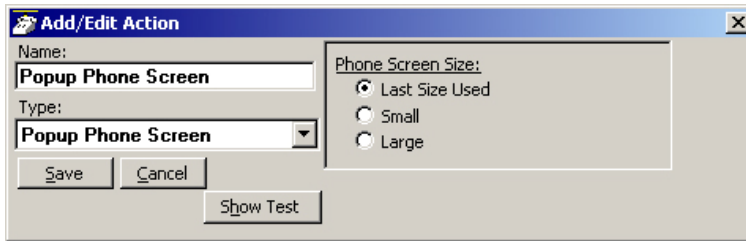

- Phone Screen Size – Select the size for Net Phone’s main screen. The choices are to restore to the Last Size Used, Small (or streamlined view), or Large (or expanded view). When Net Phone is docked to the top or bottom, Net Phone restores to settings defined in the Preferences Docking tab.

Run another Program

This action triggers the running of another program on the PC.

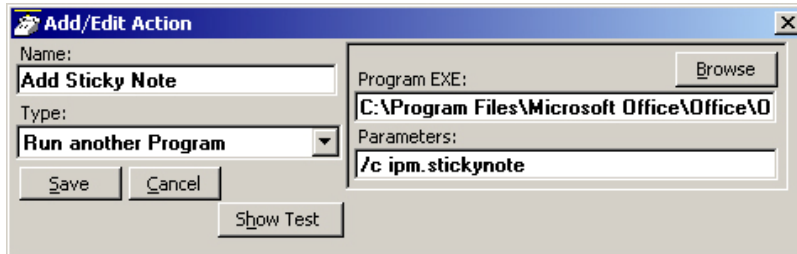

- Program EXE – Enter the name and path of the program to be run. In the example above, the program is Outlook.exe. Use the Browse button to find the file as needed.
- Parameters – Enter any additional parameters that may be accepted as part of the command line to startup the program. The example above uses Outlook to pop open a “sticky note” with data and time recorded.

Send DDE Msg

This action sends a DDE Execute message to another program on the PC. Frequently this is used to "Screen Pop" a contact management program, such as Goldmine.



- App Name Topic – The application will specify both the application name and topic name used for making the communication link. Follow the application note or that application’s documentation for specifics. Note: The pipe character ‘|’ must separate the application name and topic name.
- DDE Message – Follow the application note or the application’s documentation to define the message to be sent for that application. The format and syntax is defined by that application.
- Run Program and Program EXE – If the target program is NOT found to be running, you can have the action attempt to automatically start the program.

Send Keystrokes to a Program

This action provides a way to send keystrokes to another Windows program just as if the user typed them into that program. This can be used, for example, to pop up another program whenever a call rings in. Note: Use this action carefully because when the action is triggered, the keystrokes will be sent to the target program regardless of the state of that program (i.e. even when the user is in the middle of some action in that program).

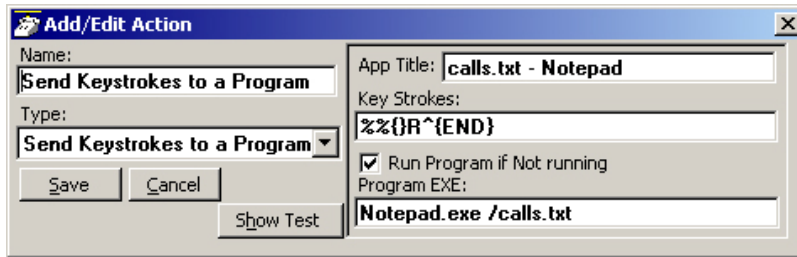

- App Title – must exactly match the text in the title bar of the target program (not case sensitive).
- Key Strokes – You can send any keys including special keys (see below). One or more characters represent each keystroke. To specify a single keyboard character, use the character itself. For example, to represent the letter A, use "A" for key text. If you want to represent more than one character, append each additional character to the one preceding it. To represent the letters A, B, and C, use "ABC" for key text.
- Run Program if Not Running – If the target program is NOT found running, you can have the action attempt to automatically start the program.
- Program EXE – Enter the path to the program to be run and a command-line parameter when needed to the target program for startup. Use a forward slash after the EXE name and before the command line parameter(s).

Example Action:

The example in the diagram sends keystrokes to the Notepad program to Pop up (restore) the program and to move the cursor to the end of the file.

1. App Title: The App Title must match exactly what appears in the title bar of Notepad: calls.txt - Notepad

2. Key Strokes: To restore Notepad (Alt Sp R): Key Strokes:= %% { }R and to move to the end of the file (Control+End): append to Key Strokes: ^{END}
3. In Program EXE: Enter program name and file name to open “Notepad.exe / calls.txt”.

Note The forward slash after "Notepad.exe" is needed to allow the command-line parameter "/calls.txt" to be used. The result is that the file “calls.txt” will open, if not open, and popup with the cursor at the end of the file allowing additional entries to be made.

Special Keys

The plus sign (+), caret (^), percent sign (%), tilde (~), and parentheses () have special meanings. To specify one of these characters, enclose it inside braces. For example, to specify the plus sign, use {+}. Brackets ([]) also must enclose them in braces. To send brace characters, use {{ } and { }.

To specify characters that aren't displayed when you press a key (such as Enter or Tab) and keys that represent actions rather than characters, use the codes shown below:

Key	Code	Key	Code
Backspace	{BS} or {BKSP}	Tab	{TAB}
Break	{BREAK}	Up Arrow	{UP}
Caps Lock	{CAPSLOCK}	F1	{F1}
Clear	{CLEAR}	F2	{F2}
Del	{DEL}	F3	{F3}
Down Arrow	{DOWN}	F4	{F4}
End	{END}	F5	{F5}
Enter	{ENTER}	F6	{F6}
Esc	{ESC}	F7	{F7}
Help	{HELP}	F8	{F8}
Home	{HOME}	F9	{F9}
Ins	{INS}	F10	{F10}

User-Defined Actions

Creating Actions

Key	Code	Key	Code
Left Arrow	{LEFT}	F11	{F11}
Num Lock	{NUMLOCK}	F12	{F12}
Page Down	{PGDN}	F13	{F13}
Page Up	{PGUP}	F14	{F14}
Right Arrow	{RIGHT}	F15	{F15}
Scroll Lock	{SCROLLLOCK}	F16	{F16}
Spacebar	{ }	Control	^
Shift	+	Alt	%%

Combination Keys

To specify keys combined with any combination of Shift, Ctrl, and Alt keys, precede the regular key code with Shift, Ctrl, or Alt code.

To specify that Shift, Ctrl, and/or Alt should be held down while several other keys are pressed, enclose the code in parentheses. For example, to have the Shift key held down while E and C are pressed, use "+(EC)". The code "+EC" will send the characters Ec instead of EC and "E+C" will send the characters eC.

To specify repeating keys, use the form {key number}; you must put a space between key and number. For example, {LEFT 42} means press the Left Arrow key 42 times; {h 10} means press h 10 times.

Note Keystrokes cannot be sent to an application that is not designed to run in Microsoft Windows (MS-DOS programs, even in a DOS window) nor can the Print Screen (PRTSC) key be sent to any application.

Set Phone Do Not Disturb

This action sets the phone's Do Not Disturb feature in the PBX (requires the PBX to support this feature via OAI link) and sets a reason for this status. This reason message displays on the phone's display as well as appearing on Net Phone and the DSS keys of other users of Net Phone.

The screenshot shows a dialog box titled "Add/Edit Action" with the following fields and options:

- Name:** Set Phone Do-Not-Disturb
- Type:** Set Phone Do-Not-Disturb (dropdown menu)
- DND Message:**
 - Match Phone's DND
 - This Message...
- Set DND on:**
 - My Phone
 - My Secondary
- DND Message Selection:** IN MEETING UNTIL (dropdown menu)
- Custom 2nd Line:** &U+'60'

Buttons: Save, Cancel, Show Test

- DND Message – The normal is to use the message defined below, but can be created to provide the same message as provided on the phone.
- Set DND On – Choose the device for which this action is to apply, the primary phone or the secondary phone.
- Choose DND Message – Select from the available messages in the drop down list for the message that appears in the upper line of the phone's display.
- Custom 2nd Line – Optionally enter a second line to display on the lower line of the phone's display message. Note: Action Variables may be used including the time variable plus 'x' minutes to set a current time plus 60 minutes in the example above.

Set Phone Status Message

This action works much the same as Set Phone Do Not Disturb except it does not change the phone's DND status and the message only appears within Net Phone and the DSS keys on other users of Net Phone.

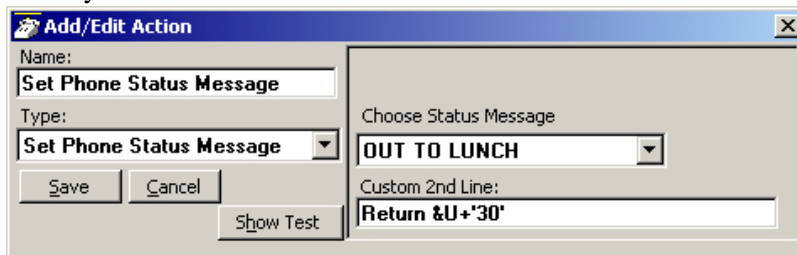

The screenshot shows the 'Add/Edit Action' dialog box. The 'Name' field contains 'Set Phone Status Message'. The 'Type' dropdown is set to 'Set Phone Status Message'. The 'Choose Status Message' dropdown is set to 'OUT TO LUNCH'. The 'Custom 2nd Line' text box contains 'Return &U+'30''. There are 'Save', 'Cancel', and 'Show Test' buttons.

- Choose DND Message – Select from the available messages in the drop down list for the message that appears in the upper line of the phone's display.
- Custom 2nd Line – Optionally enter a second line to display on the lower line of the phone's display message. Note: Action Variables may be used including the time variable plus 'x' minutes to set a current time plus 60 minutes in the example above.

Set Phone Forwarding

This action changes the Call Forwarding setting of the phone in the PBX for the prime DN of the phone. The action can determine the type of forwarding (Immediate, Busy, No Answer, Busy/No Answer, or Off) and the destination.

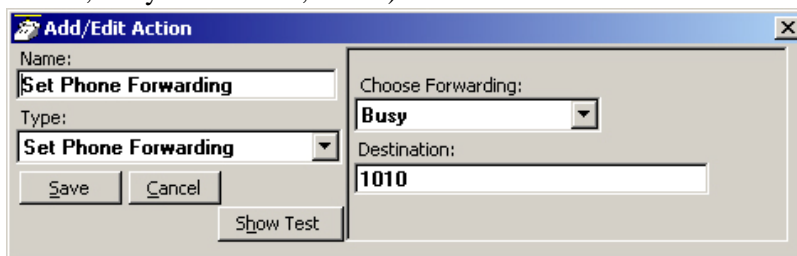

The screenshot shows the 'Add/Edit Action' dialog box. The 'Name' field contains 'Set Phone Forwarding'. The 'Type' dropdown is set to 'Set Phone Forwarding'. The 'Choose Forwarding' dropdown is set to 'Busy'. The 'Destination' text box contains '1010'. There are 'Save', 'Cancel', and 'Show Test' buttons.

- Choose Forwarding – Select from the drop down list the forwarding action to use.
- Destination – Define the number for the destination of the forwarding. This is left blank when using Forwarding Off.

System/PBX Command

This action can be used to send appropriate OAI commands to the PBX to perform functions. For example, you could have an action that sets your DND message to "UNAVAILABLE" using the following: N 16. You could then set this action to run each time you shutdown your phone.

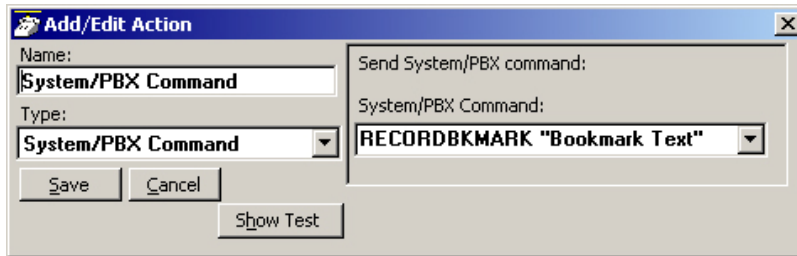

- System/PBX Command – Select from the list of available commands and edit the variable values (shown in quotation marks) as needed. The commands available are as follows:

ANSWER	
CONFERENCE	
DIALxxxxx	Where xxxxx is the number to be dialed. Digits 0~9,*,#. A ‘;’ is a pause and ‘!’ is a hook-flash.. Parenthesis, semi-colons, dashes, and spaces are ignored, thus (480) 496-9040 can be entered.
HANGUP	
HOLD	
MODIFYCALL “Field”, “Value	Recommend using Modify Call Information or Attach Acct Code action.
TRANSFER	Recommend using Transfer Call action.
Recording Option	When Recording is active on Net Phone.
RECORD	
RECORDBKMAKR “Text	Substitute your bookmark text for “Text”
RECORDSTOP	

User-Defined Actions

Creating Actions

ACD Option	When ACD is available on some PBXs.
ACD HELP	
ACD PU	
SET WORKUNITS	

Transfer Call

This action causes the active call to be transferred to another phone, directly to a specific Voice mailbox, or to an outside phone number (i.e. 9,4969040).

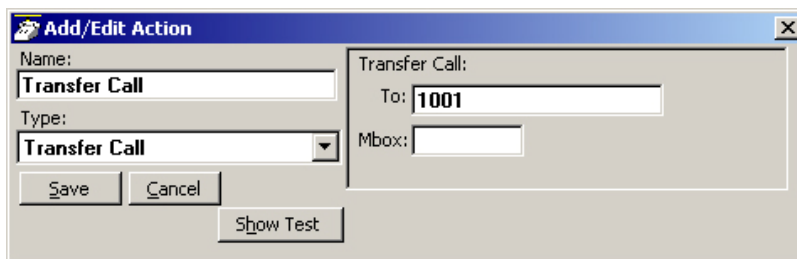

The screenshot shows a dialog box titled "Add/Edit Action" with a close button (X) in the top right corner. The dialog is divided into two main sections. On the left, there is a "Name:" field containing "Transfer Call" and a "Type:" dropdown menu also set to "Transfer Call". Below these are "Save" and "Cancel" buttons. On the right, there is a "Transfer Call:" section with a "To:" field containing "1001" and an "Mbox:" field which is empty. A "Show Test" button is located at the bottom center of the dialog.

- Transfer To – Enter an extension number or outside number to be called.
- Transfer Mbox – Enter a mailbox number if going to a Voice Mail number.

Action Variables

Net Phone uses variables to provide information to actions. Net Phone replaces the variable token code with the appropriate value when the action executes. For example, %P becomes '4804969040' when you receive a call from CTS.

Call Variables

Refer to the table below for call variables and their values.

Variable	Information
%A	Account Number
%B	Call Direction ("In" or "Out")
%C	DNIS Called Name
%D	DNIS/DID Number
%E	This Net Phone's Extension Number. (Can be used for Primary DN or Secondary DN when using Set DND Action.)
%F	Call Forwarded from Extension number
%G	DND Message, when phone is in DND. (Can be used for Primary DN or Secondary DN when using Set DND Action.)
%H	Calling Number (hyphenated – type 1, format defined in agnt_ph.ini)
%I	TAPI Call ID
%J	Calling Number (hyphenated – type 2, format defined in agnt_ph.ini)
%L	Elapsed Time of Call (H:MM:SS)
%M	Main Listed Phone Number (Use with Export Call Info actions)
%N	CallerID Name (outside calls only, requires CallerID)

User-Defined Actions

Action Variables

Variable	Information
%OR("field") or %OC("field")	Outlook Calendar/Reminder "fields": 1. "SUBJECT" – subject field of Outlook event. 2. "START" – start Date/Time of event. 3. "END" – ending Date/Time of event. 4. "IMPORTANCE" – Importance (Low, Normal, High) of event. 5. "LOCATION" – location of event. 6. "ADVANCE" – number of minutes of advance notice. 7. "STATUS" – Busy status (Free, Busy, Out of Office) of event. 8. "STIM" – start Time without the Date. 9. "DIFF" – time difference before event start, e.g., 15 minutes will report "15 Minutes". Used for text to speech announcements.
%P	Incoming: CallerID Number / ANI; Outgoing: Dialed Number
%S	Call Answered ("Y"es or "N"o)
%T	Call Type ("IC" or "CO"): IC= Intercom call; CO= Outside call.
%V	The Extra Call Info screen allows you to configure a button for each Call Info field. This variable, %V, contains the value of that Call Info field for use when defining an Action trigger.
%W	Contains '1' if Outlook Link found a match in Outlook. Contains '0' if Outlook Link did not find a match, or was not active.
%X("name")	Extra Call Info Field, i.e. %X("Notes"). The name of the field must be in double quotations. For a list of field names in your system, go to Preferences>General Tab>Extra Info button, Add and use the pull down list for fields available on your system.
%Y	Contains the Outlook Unique Identifier if Outlook Link found a matching record in Outlook.
%Z	Call Status ("Ringing", "Talking", etc.)

Note Insert +x following the '%' character to restrict the variable value to the first 'x' or leftmost characters. Insert -x to restrict the variable value to the last 'x' or rightmost characters. For example, to pass the first 8 characters of the Calling Party Name, enter: %+8N. To send the last 4 digits of the Calling Phone Number, enter: %-4P.

System Variables

Net Phone also uses System Variables for Action parameter strings, such as Date and Time. They can also provide some control over text logging actions with Carriage Return, Line Feed, Tab, and Random Numbers (for file names.) Note: Many System Variables duplicate the Action Variables to provide increased compatibility with legacy applications and 3rd Party Application Notes.

Variable	Information
&A	Account Number
&B	PBX Call ID
&C	Insert a Carriage Return character
&D	Insert the Date in format: "mm/dd/yy"
&E	Insert Extension Number of My Phone
&F	ACD Group Name
&G	Agent ID
&H	Calling Phone Number (hyphenated - type 1)
&I	TAPI Call ID
&J	Calling Phone Number (hyphenated - type 2)
&K	ACD Group extension number
&L	Insert a Line Feed character
&N	Calling Party Name (outside calls only)
&n	Insert the Date and/or time in user-specified format i.e. "&Nhh:mm:ss AM/PM&"
&P	Calling Phone Number
&Q	Random Variable (6 digits)
&R	Random Variable (8 digits)
&T	Insert the Time in format: "HH:MM" (24 hour clock). See Note 1.
&U	Insert the Time in US format: "H:MM AM/PM". See Note 1.
&V1	VoIP Ringer Audio device (Soft Phone must be used to use)
&V2	VoIP Headset Audio device (Soft Phone must be used to use)
&X	Destination Field (for Export of Call Info)
&Y	Call Type ("IC" or "CO"): IC= Intercom call; CO= Outside call.
&t	Insert a Tab Character
%%	Insert a Percent "%" character
&&	Insert an Ampersand "&" character

User-Defined Actions

Action Variables

Note &T and &U variables accept a relative addition of time in the format &U+'30' results in the current time plus 30 minutes. The number of minutes must be within single quotation marks. Example: A Set Phone Status Message action can be specified selecting the OUT TO LUNCH message and a second line of UNTIL &U+'30'. If this action is used at 11:55 AM, then the resulting message on Net Phone is OUT TO LUNCH UNTIL 12:25 PM.

Examples for Text Reader/Announcer:

Speak Reminder: SPEAK,"Reminder,%OR("SUBJ"),Starting %OR("DIFF"),&V1,&V2
Speak Appointment: SPEAK,"Appointment,%OC("SUBJ"),Starting Now",&V1,&V2
Announce Call: CA,%T,&F,"%N",%H,&V1,&V2

Exporting Actions

Once an action has been designed, exporting the action is recommended to provide a backup copy as well as a file that can be copied to other Net Phones. To export an action, you will need to be in the Add/Edit Action screen and click the Show Test button to reveal the testing parameters and the Export Action button. Pressing Export Action copies the details of the action into a special file named: xx.ACI where 'xx' is a number assigned by the software corresponding to the action number (i.e. 2.ACI).

This file is exported into the user's application data folder (typically, "Ö\Documents and Settings\<user name>\Local Settings\Application Data\CTS\netphone"). In order to identify the file more easily you may want to use Explorer to rename that file to something more appropriate (i.e. PLAYBELL.ACI). When renaming an action file always limit the file name to 8 characters prior to the .ACI extension. This file can then be copied to another PC to give a copy of the action to another user of Net Phone. Leaving a copy in this folder provides a backup copy of the action. That will be then be loaded at startup if that action were deleted in the Actions List (see Importing Actions below for more details).

Note: When exporting an action, if a file with that name already exists, an error message will occur and the action will not be copied – when this occurs you will need to use Explorer to rename the existing file and then export again.

Importing Actions

When the Net Phone program starts up, it automatically imports actions from the compiled NET_PHN.ACS action file plus all action files (*.ACx) it finds in its startup folder. The last character used in the extension of the file name defines how the action file is treated on importing:

- .ACI – These files are individual actions created by Exporting Actions. These will be imported only when an action using the same action name does not exist in the compiled file. Thus, when this file exists and the user had made changes to this action, the user can revert back to the original operation by deleting the current action in Net Phone then stopping and restarting Net Phone.
- .AC1 – Upon startup, Net Phone always imports all “One-Shot” action files (*.AC1). When an action of the same name exists, the action will be overwritten. Once imported, the One-Shot export files are deleted. These one-shot files can thus be used to import an action just one time allowing the user to change or delete the action as desired.
- .ACO – Upon startup, Net Phone always imports all “Over-Write” action files and overwrites any action with the same name. These are useful to ensure the actions do not get changed or when making corrections on other Net Phones.
- .AC0 – This type of file is only imported at initial startup of the Net Phone or when the compiled actions file “AGT_PHN.ACS” is not found at startup.

These files allow you to design an action, export it, rename it, and then copy the file to all PCs that need that action. These are also useful to overcome a user accidentally deleting an action since they can have a copy of that file on their PC, when they exit and restart Net Phone that action will be restored.

Testing Actions

While in the Add/Edit Action screen, a Show Test/Done Testing button is offered. Pressing this button when it is titled Show Test, will expand the window to a set of "Test Values" that can be set representing the variables used within the action. This sets the values of any real time variables for testing your action. For example, if your action will be using the "Phone Number" variable (%P, %H, or %J) you will want to set the test value of %P to the phone number you want to simulate (i.e. 7145551234). Then press the Perform Test button to test your action. The "Test Results" screen will show the results of the test and if the action fails, you can change the parameters of the action and test again. When another application is involved in the action, that application, in general, will need to be installed and running to perform the test. Pressing the button titled Done Testing will close the "Test Window".

Note If the action seems to work fine when you test it from this screen, but doesn't seem to work properly when the action is used by the Call Handler you may want to open the Main Menu Icon --> Setup --> Advanced --> Show Events screen (see your System Administrator if you do not have the Advance menu item) to see what is actually occurring when that action is being used.

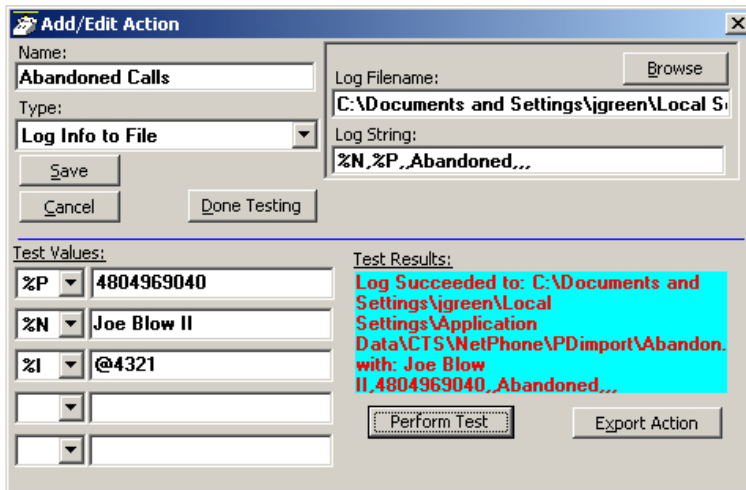

This chapter defines how to use PBX features from Net Phone. Features included are Call Handling, PBX, Call Center, and Outlook features. Personal Call Handler rules can be created to respond and take actions on calls automatically, or Programmable Buttons can be used for even easier access to many features.

Call Handling Features

Call Handling features include how to dial, answer, hold, transfer and hang up calls. It also includes how to view the Extra Call Information when attached to a call.

Making Outgoing Calls

Net Phone supports a number of ways to place calls including open architecture links to other programs or contact managers, which can also be used to dial calls. The following are some of the typical ways to place a call using Net Phone.

► Manual On-screen Dialing

1. Click within the dialing number window and enter the number from the keyboard.
2. Press Enter when done to start the number to be dialed.

► Re-dial a Recently Used Number

1. Pull down the list of numbers in the dialing window and select the number to dial.
2. Click the dial button  for dialing to proceed.

► Using Net Phone Dialpad

1. Click the dialpad button  to expose the dialpad.
2. Enter the number to be dialed including a trunk access code; the call will proceed automatically once a valid number is entered.

► Hot Key Dialing

1. Highlight a telephone number in another application.
2. Using the keyboard, press the key combination assigned for Hot Key Dialing. The call will proceed dialing the number highlighted.

► Using Drag and Drop

- Use the mouse to drag and drop a call from either the Call History or Speed Dial list into the Dialing window. The call will proceed to dial.
- or use the mouse to drag and drop a call from either the Call History or Speed Dial list into the LCD Display window. The call will proceed to dial.

► Using Personal Speed Dial List

1. Click the Speed Dial Companion Option button to open your Personal Speed Dial listing.
2. Make a selection from the listing and double-click the name to proceed dialing or right-click on the selected name and choose Call Now to proceed.

► Using Call History to Re-dial a Number

1. Click the Call History button.
2. scan the list for a recently dialed number or look for a number of someone that called you.
3. Right-click on the line with the person to call and select Call Now or double-click on the line with the person to call.

► Using Speed Dial User Button

- Click on a User Programmable button that has been programmed as a Speed Dial button. The call will proceed immediately.

Answering Calls

Typically the longest ringing calls are answered first, but calls can be answered in any order with a click of the button.

► To Answer Oldest Call

- While a call is ringing, click the Answer button  .
or double-click on the top call in the Calls View Window.
or press the Answer Hot Key (F9). Note: Net Phone must have focus for the key to work.

► To Answer Calls in Any Order

- Double-click on the selected call in the Calls View Window.

► To Answer a Call while Talking (Call Waiting)

While on an existing conversation, another call may ring. The existing call can be placed on hold and the ringing call answered.

- While talking on an existing call and another call rings in (not marked “Campon”), click the Answer button
or double-click on the ringing call in the Calls View Window
or press the Answer Hot Key (F9). Note: Net Phone must have focus for the key to work.

► Hanging Up or Disconnecting Calls

- When the call is completed, click the hangup button  to disconnect the call
or right-click on the call in the Call View Window and select Hangup.
or press the Hangup Hot Key (F12). Note: Net Phone must have focus for the key to work.

Transferring Calls

► Using Transfer Button

1. While talking with a caller, click the transfer button  to get intercom dial tone or right-click on the call in the Call View Window and select Transfer.
2. Using the keyboard enter the number to transfer the caller to, press Enter when done.

or use the on-screen dial pad  and dial the number. Once the PBX recognizes a valid number, the call will proceed automatically.



► Using Drag and Drop

- While talking with a caller, use the mouse to drag and drop the call from the Calls Window onto a DSS button for immediate transfer to another station.

or use the mouse to drag and drop the call from the LCD display window onto a DSS button for immediate transfer to another station.

Viewing Extra Call Information

Net Phone has the ability to attach, retain, and display extra information taken on a call. This could include information input by an IVR, added/attached information by the Call Router, attached from a database, or added by any user who handled the call. This information is retained with the call as it is transferred about in the phone system. The following Call Info icons are displayed in the Calls window or LCD Display to indicate the presence of additional information. The icon changes color depending upon the information available:

-  – No call information attached to this call.
-  – Normal call information attached to this call.
-  – At least one field of priority call information is attached.

► To View Call Information

Click the "Call Info" icon  on the right side of the Call key for the desired call. This window can contain many different fields depending on your configuration and the call information attached. Note: These windows can automatically popup whenever a new call arrives by using the Popup Call Info Screen action in the Personal Call Handler.

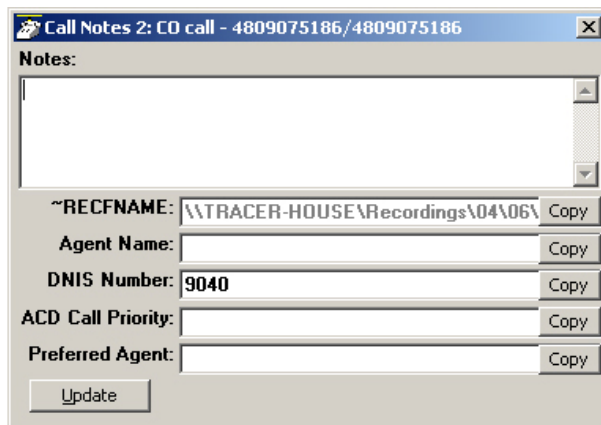

~REFCNAME: \\TRACER-HOUSE\Recordings\04\06\		Copy
Agent Name:		Copy
DNIS Number:	9040	Copy
ACD Call Priority:		Copy
Preferred Agent:		Copy

Update

► To Add or Change Information

1. With the “Call Info” window open, place the cursor into the box to be changed and use the keyboard to add or erase information.

Note The ability to add or change information is controlled by Preferences>Extra Info settings.

2. Click the Update button to save the new information. Once changed, other programs will use this information. For example, the call is being screened and transferred into an ACD queue; the caller could define a Preferred Agent by entering an agent’s ID into the Preferred Agent Information field. When the call is transferred this information is available to be used by the ACD application.

► To Copy Call Information to Another Application

With the “Call Info” window open, click the Copy button to place that specific information on the Windows clipboard for pasting into another program. For example, the user may need to use the Customer number to look up the status of an order. Clicking Copy and switching to the other program and pasting into the appropriate field allows for a fast lookup.

Holding Calls

► To Place Call on Hold

- While talking with a caller, click the hold button  to place call on hold or right-click on the call in the Call View Window and select Hold from the menu.

► To Retrieve Call

- To re-connect a held call, click the hold button again or double-click on the held call in the Call View Window or right-click on the held call and select Answer from the menu.

Phone Feature Operation

Status messages and Call Forwarding is available on Net Phone.

Status Messages

User can set the Status message so that others can know the user's status.



► Setting DND Message Only

1. Right-click the **DND off** button to bring up the Set DND or Status Message window.
2. Change the selection to Status Msg Only On
3. Use the pull down listing and select a DND Message.
4. When needed enter additional information on the Custom 2nd Line.
5. Click the Save button when done. DND will not active, but the status message will appear on the DSS keys throughout the system.

► Turning Off DND or Message Only

1. Right-click the **DND ON** button to bring up the Set DND or Status Message window.
2. Click the All Off button to remove either DND and/or the Status Message.

Call Forwarding

► To Set Call Forwarding

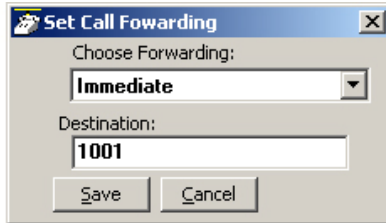

1. Right-click the **FWD off** button.
2. Choose a Forwarding type from the pull-down listing.
3. Enter a Destination for the forwarded calls.
4. Click Save to complete the setting.

► To Clear Call Forwarding

1. Right-click the **FWD ON** button.
2. Choose <None> from the pull-down listing.
3. Click Save to remove the previous setting.

Call Center Features

The ACD actions can be used to Log In / Log Out to/from ACD groups. Going temporarily unavailable and an ability to end wrap times can be part of the features available. Additional Call Center features are possible using User Programmable buttons.

Logging In or Out

- Click the ACD Log button to open the ACD Login/Logout window.

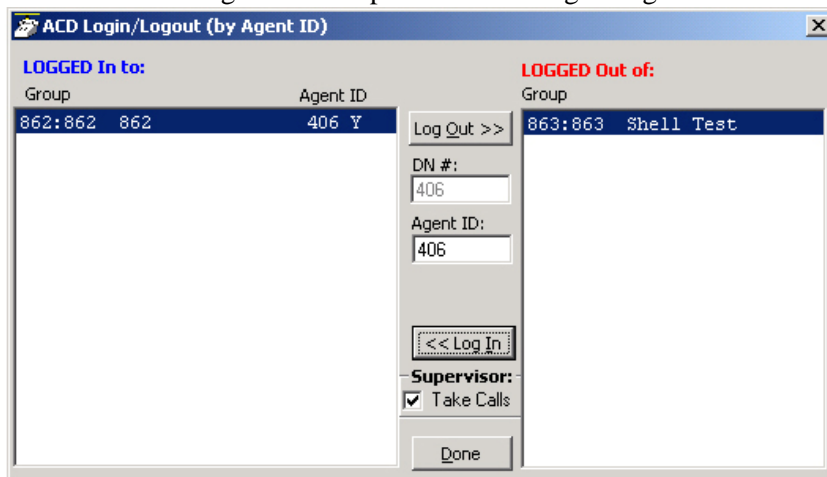

Note The right list box shows available groups for the identified agent number. The left list box shows groups currently logged into.

➤ To log into or out of one or more groups

1. Highlight the group name(s) in the right-hand box and click <<Log In. If your Agent ID is listed as a Supervisor, then the Supervisor: Take Calls check box will be offered on your screen. Placing a check in this box will log you in to take calls for the group(s) selected when <<Log In was pressed.
2. Click Done when finished.
3. The ACD Key will display the number of ACD groups the extension is logged into and the total number of ACD groups you are a member.

► To Log Out

1. Highlight the group name(s) in the left-hand box and click the >>Log Out button.
2. Click Done when finished.

Changing Agent Status

1. Click the ACD Status button. The following ACD Agent Status window will appear:

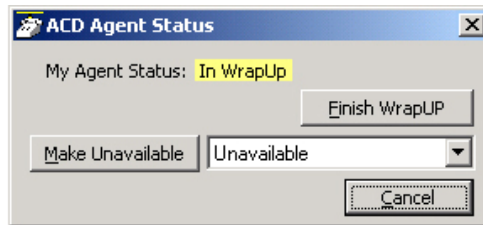

► To Make Agent Unavailable

1. Use pull-down list and choose a reason.
2. Click the Make Unavailable button.
3. Click Done.

► To Make Agent Available

1. Click the Make Available button.
2. Click Done.

► To Set the ACD Status to WrapUp

1. Click Set WrapUp button.
2. Click Done.

Note The Set WrapUp button is NOT available on all installations.

► To End WrapUp

1. Click the ACD Status button.
2. Click the End WrapUp button.
3. Click Done.

Plantronics Wireless Headset

CS50-USB and CS60-USB DECT

This is a User Guide for Plantronics USB Wireless headsets used with Net Phone 5.0 Softphone. Key features when used with Net Phone 5.0 include:

- Net Phone interfaces directly with the CS50-USB or CS60-USB DECT headsets without any middleware software.
- Each Net Phone user can select from 100's of different sounds to be played when a call is ringing. Also, a ringer in the headset can be activated by checking the USB Ringer option ("Use USB Ringer?") in the Net Phone Audio Settings.
- The "Answer" button on the side of the headset can be used to answer and terminate calls directly from the headset.
- A "Smart" button on the back of the headset can be used to hold a current call and answer a waiting call



Connecting Headsets

Plantronics Wireless Headset

- The headset power is automatically turned off by Net Phone whenever a call is not active and automatically restored upon receiving a call to save talk time battery.
- The speech volume (listening) can be adjusted on the headset as well as on Net Phone, and the microphone volume (talking) can be easily adjusted in Net Phone.

Please refer to Plantronics User's Guides for installation, setup, battery changing and other items for operating your Wireless Headset.

Installation

- The software modules needed for Plantronics are installed automatically with the Net Phone installation. All configuration information for Plantronics to work properly is part of this installation.
- We recommend not running the Plantronics PerSonoCall application -- disable the option to "Launch PerSonoCall whenever Windows starts," and shut down the application.
- If you are running the Plantronics PerSonoCall, always disable the option: "Enable headset only for phone calls (extends battery life)."

Note Plug in the headset USB cord and make the power connection for the base unit – Some PC USB ports provide enough power so that the external AC power transformer does not need to be used.

- With Net Phone running, right-click the Audio/SPKR button to access the Audio Settings dialog box. Make the following settings:

Sound Board/Device:	USB Audio Device or CS50/CS60-USB Headset	The device for the headset
Audio Device Type:	USB Headset	This activates the control buttons on the headset.

Headset Controls and Operation

- **Charging Indication (1)** – Red LED on left side of base indicates when the headset is being charged. This indication is part of the Plantronics Headset base and not affected by Net Phone 5.0.
- **Status Indication (2)** – Green LED on right side of base lights when powered. This LED flashes when the wireless connection is active and transmitting. It will be steady when powered up and idle. Net Phone 5.0 sends a command to shut down the wireless transmission when no call is active to conserve the battery for talk time.

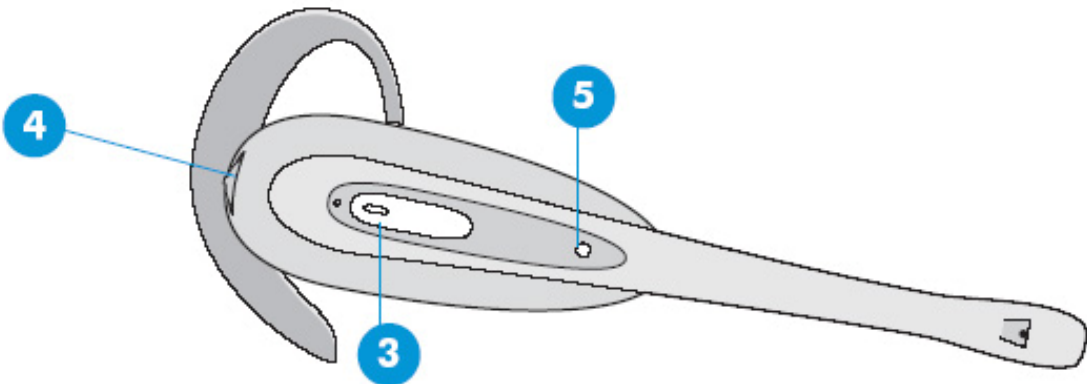
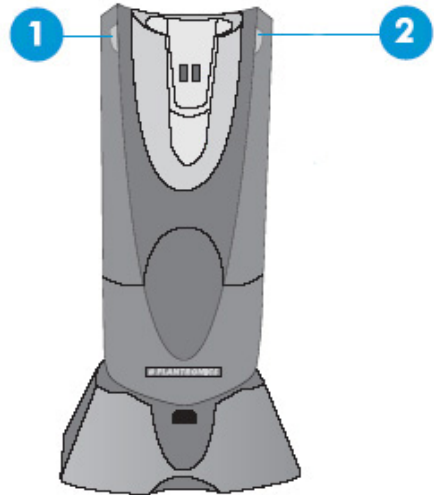

- **Answer/End Call Button (3)** – This button functions like a “Speaker” key on a phone -- Pressing this button will answer a ringing call. Pressing the button again will end the call. If disconnecting a call while another call is holding, the first press of this button will end the current call and then a second pressing will pickup the holding call.

Connecting Headsets

Plantronics Wireless Headset

- **Listen Volume Control (4)** – Pushing the button up will raise the volume in the ear piece, pulling the button down will lower the volume in the ear piece. Each push will step the volume level up or down one level.
- **Smart Button (4)** – This button functions similarly to a Hold button on a phone – note you must press and hold this button for 2 to 3 seconds for it to operate. If you're talking on a call, pressing this button will put the call on hold -- to retrieve the call from hold, simply press this button again or press the Answer/End Call button. If you're talking on a call and a 2nd call rings into your phone you will hear a Call Waiting ring – pressing this button will put the 1st call on hold and answer the 2nd call. You can put the 2nd call on hold but pressing the button again, and then pressing it again will retrieve the 1st call from hold, and so on.
- **Talk Indication (5)** – An LED that lights when the user is talking (active) over the headset.

Net Phone Audio Setup Screen

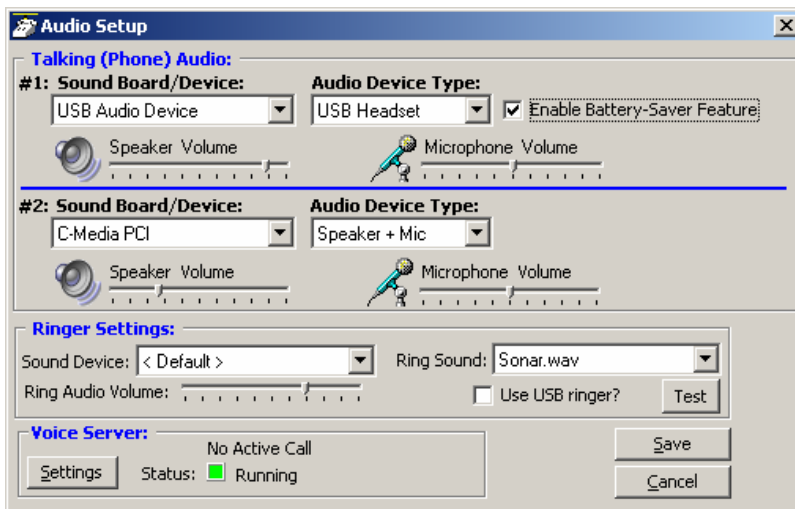

Trouble Shooting

If you loose audio on a call after about 6 seconds, check for the Plantronics PerSonoCall application and disable the option: "Enable headset only for phone calls (extends battery life)"

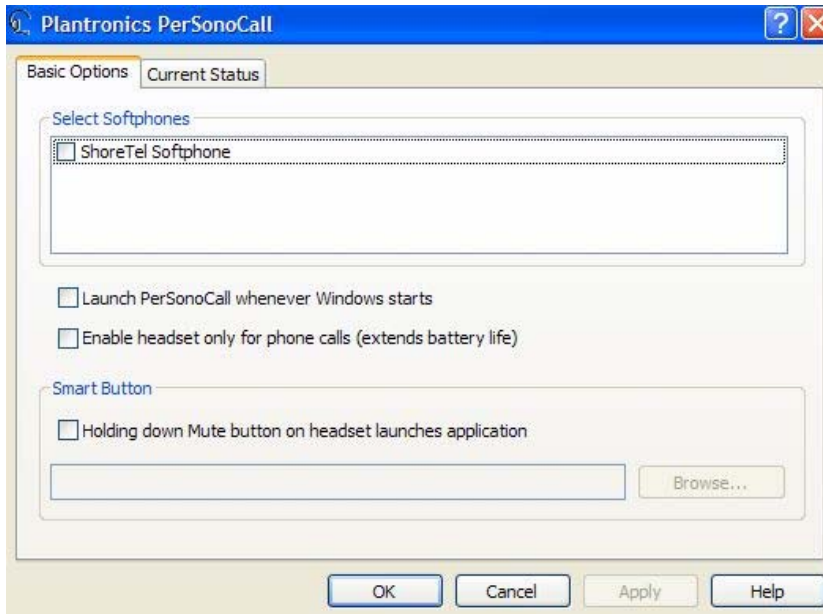

This page is intentionally left blank.

Dialing from within Outlook

When Outlook Phone Link has been installed, a "Phone Icon" will appear on your Outlook main Tool bar. Then when you are in any Outlook Contacts folder and you have a contact highlighted, you can press this button to dial. A dialing screen will pop up showing each of the phone numbers available for that contact. Simply select the appropriate phone number and press the Call button to place the call. Note: Please refer to the on-line help file in Outlook Phone Link for available dialing options.

When the call is being dialed in Net Phone, the name from the Contact will be automatically attached to the phone call (for display on the LCD, the Call Key, SMDR, etc).

Incoming Calls

Using the Personal Call Handler you can set up a rule(s) to automatically run the "Lookup In Outlook" action. This action will then lookup the phone number in Outlook and, depending on how your action is configured, will pop open a Contact and/or a Journal.

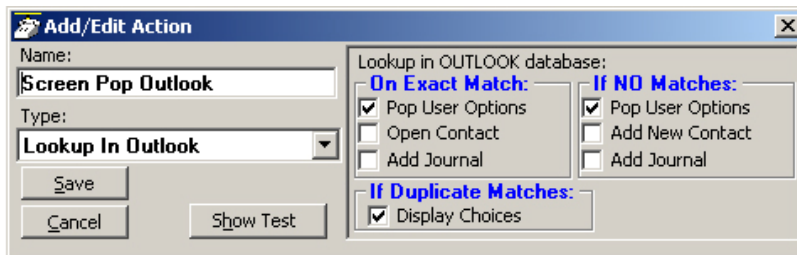

Note If you setup a rule to trigger on "When Ringing", you may NOT want to have the action automatically open a Contact or Journal because it will do this for every matching call whether you are present or not. So, if while you're away from your desk, you have missed 20 outside calls that rang on your phone, you could have 20 different Contact screens and 20 Journal screens popped up on your PC screen. A better alternative is to have your "When Ringing..." trigger use Pop User Options instead of the Open Contact or Add Contact or Add Journal options. Now, when a call is ringing on your phone, a small "User Options" window will pop up showing the Contacts that match the phone number (if any) as well as buttons that let you manually "Open/Add Contact" or "Add Journal".

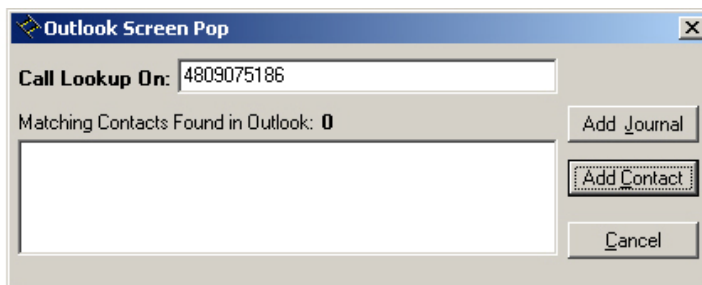

With this, you can see the information about who is calling and then can manually open a Contact or Journal. If opening a contact/journal manually is not desirable, you could also have a 2nd 'trigger/action' so that when you "Answered" a call it would automatically open a Contact and/or Journal as desired.

While on a Call

Whenever you are on a telephone call (incoming or outgoing) you can right-click on the call (Call Information or LCD Display window) and select "View Info" to pop up the Standard Call Info screens shown below. Within these screens, buttons are offered to Open Contact, create a New Contact, Lookup the person in Outlook, or open a Journal (Add Journal) entry in Outlook. These screens can also automatically pop up by setting up a Personal Call Handler rule using a trigger to run the "Popup Call Info Screen" action (i.e. whenever you answer a call). A feature may also be available to you, depending upon support for your PBX, to divert the call (Divert Call) to another destination.

The dialog box titled "Standard Call Info" displays the following information:

- Phone Number: 6298723
- Name: Joyce Green
- Account #: [Empty]
- DID Name/#: <none>/<none>
- FWD/Xfr From: [Empty]

Buttons: Cancel, Modify Call, [Icon]

Outlook section:

- Open Contact
- Add Journal

Divert Call section:

- To: [Empty]
- Vmail Box: [Empty]

Contact Match found

The dialog box titled "Standard Call Info" displays the following information:

- Phone Number: 17148032395
- Name: [Empty]
- Account #: [Empty]
- DID Name/#: <none>/<none>
- FWD/Xfr From: [Empty]

Buttons: Cancel, Modify Call, [Icon]

Outlook section:

- New Contact
- Lookup
- Add Journal

Divert Call section:

- To: [Empty]
- Vmail Box: [Empty]

Contact Match not found

Integrating with Outlook Calendar

One typical integration with Outlook Calendar is to put Appointment information on DSS key such that all other Net Phone users know your current presence status. This example will turn on the DSS key with Status Message only and turn off the message when the scheduled meeting is over.

Step 1: Create Actions to set and clear the DSS Message

The first Action will set a Status Message and add the Subject field of the Appointment as part of the message. On the DSS key, the first line and second line are appended to each other, thus the preset Status Message can be modified to become something very simple to allow for the Subject to become the predominant part of the message.

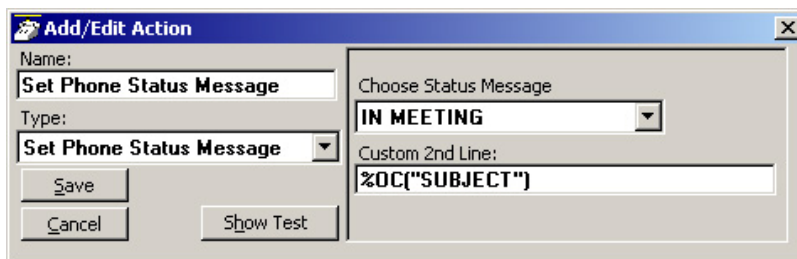

The second Action will clear the message when the appointment ending time is reached.

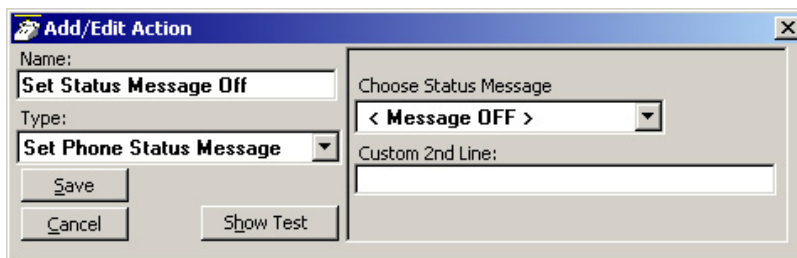

Step 2: Create Personal Call Handler Rules

Two Personal Call Handler Rules will be needed, both using the Outlook Calendar Appointment event which sends a message when an appointment starts and a second when it ends. In this example, I want to trigger the setting of the DSS message for any Calendar Status to ensure all appointments are reflected and also for any Event Importance and any Subject. These items are part of the appointment created in Outlook Calendar. When this event triggers, I want to use the first Action that I created which sets a message “In Meeting” and appends the Subject line to the message to be displayed.



The second rule will trigger only when the Appointment sends an indication of the Appointment be set to a “Free” status. The action is to turn off the DSS message.



Step 3: The Final PCH Rules

The main thing is to ensure that the PCH rule to “Clear DSS Message” must follow “Set DSS Message”. If not, the “Set DSS Message” triggers on ‘any’ Calendar Status including ‘Free’ and the clear command would be followed by a command to set the message, thus the message would never clear. The final set of PCH rules should be in the order of items 3 and 4 in the PCH Rules screen.



This powerful feature of Net Phone allows you to create Call Handling Rules to automatically take actions when certain events occur and specific conditions are true. That is, you create a rule so that (1) when an Event occurs, and (2) if certain conditions are true, and then (3) perform specific Actions. Following are a few examples of what you can accomplish with these Rules:

- When an Outside call with CallerID rings and I'm not on another call, popup Microsoft Outlook and lookup the caller info in the database.
- Whenever a Call leaves my phone but hasn't been answered, write the call info to an "Abandoned Call" file so I have a record of the call.
- Whenever I answer a call without CallerID, automatically present a screen so I can type in the caller info for that call.
- Whenever I dial a call, automatically present a screen so I can type in the name for that call.
- When that nagging broker calls, immediately transfer him to my voice mailbox.
- I'm working on an important project, so whenever anyone other than my boss calls, immediately transfer them to V-mail.
- When my spouse calls, if I haven't answered the call within 5 seconds, play a special tone on my PC to alert me.
- When I shutdown my phone, automatically log me out of all ACD groups.

Note Depending on your configuration you may not be able to change the Call Handler Rules, in which case you should check with your System Administrator.

The basic process for creating Personal Call Handling rules is to first define the actions you would like to accomplish and test them. Then you can create a Personal Call Handling Rule and choose which event will trigger the action(s) and then refine this by setting the conditions for when the trigger will occur.

Creating Personal Call Handling Rules

The following items will define how to edit, delete or add new rules. Many rules can be created and exist simultaneously. To allow rules to be defined and not applied, an enable/disable check box appears before each rule to make it easy to disable or enable different rules at different times.

The order of the listing of the rules determines the sequence the rules will be used. Thus, some rules may prevent following rules to be used. For example, if the first rule in the list causes the call to divert to another station followed by a rule to Screen Pop Outlook, then the Screen Pop will never take place. If the rules were reversed, then the Screen Pop will take place prior to the call being diverted. In either case, the user may not see the Screen Pop since the call will leave this station, thus the Screen Pop will likely disappear as well. For the user to see who is calling and provide an ability to answer the call or “do nothing”, then creating the Screen Pop to occur immediately and the Call Divert action to occur using a time delay, then the two rules would result in displaying the Screen Pop and then pausing before diverting the call. Note: This example was for illustration purposes. These two actions can actually be done within a single rule to make the creating of rules simpler.

► To Open Call Handler Rules

- Click the Main Menu Icon > Setup > Personal Call Handler
or click the button on the right side of Net Phone .

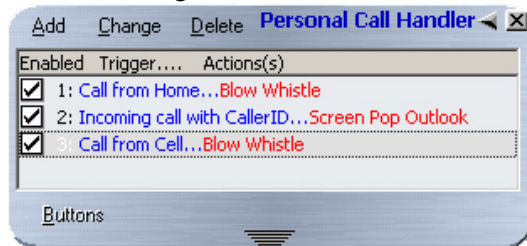

► To Delete a Rule

- Highlight the rule to delete and click Delete.

► **To Add or Change a Call Handling Rule**

► Click the Add button

or highlight the rule to be changed and click Change.

Add/Change Handler Rule

1. Triggering Event: (When this happens) (Refer to this Rule as...)
Call Ringing Call from Home

2. Conditions: (If these Conditions are True)

Call Type:
 Any IC Only
 Outside Only

Phone State:
 Any If Idle
 Busy on a Call

Caller ID Number:
 none Required
 any Number
 Blocked/Missing
 Is This #
 Is Not This #
4809075186

Extra Info:
CallerID Name
 none Required
 Is Present
 Is Missing
 Is This Value:

Account Code:
 none Required
 any Number
 Is Missing
 Is This #
 Is Not This #

3. Actions: (Then take these Actions)

a. Immediately:
Blow Whistle
Check Action

b. After: 0 Seconds
<None>
Check Action

Add Action Delete Action
Export Rule
OK Cancel

Step 1: Select a Triggering Event and Set the Conditions

The types of events that can be used to trigger a rule can be divided into call related triggers, system triggers, and status change triggers. Each grouping is show below along with the Conditions offered for the trigger to take effect:

- **Call Ringing** – Whenever a call rings on the phone.
 - Call Type – Select the call type for the ringing call.
 - Phone State – Select the Phone State when the call arrives.
 - Caller ID Number – Select the Caller ID to be used in the trigger. For the last two options, enter a specific number in the box including wildcard characters when needed. See Like Matches and Unlike Matches for use of wildcards.
 - Extra Info – Select a “Field Name” (CallerID Name, or type in another field name) and then choose how to treat this information. For the last two options, enter a specific number in the box including wildcard characters when needed. See Like Matches and Unlike Matches for use of wildcards.
 - Account Code – Select the account code type to be used. For the last two options, enter a specific number in the box including wildcard characters when needed. See Like Matches and Unlike Matches for use of wildcards.

2. Conditions: (If these Conditions are True)

Call Type: <input checked="" type="radio"/> Any <input type="radio"/> IC Only <input type="radio"/> Outside Only	Extra Info: CallerID Name <input type="text"/> <input checked="" type="radio"/> None Required <input type="radio"/> Is Present <input type="radio"/> Is Missing <input type="radio"/> Is This Value: <input type="text"/>
Phone State: <input checked="" type="radio"/> Any <input type="radio"/> If Idle <input type="radio"/> Busy on a Call	Account Code: <input checked="" type="radio"/> None Required <input type="radio"/> Any Number <input type="radio"/> Is Missing <input type="radio"/> Is This # <input type="radio"/> Is Not This # <input type="text"/>
Caller ID Number: <input checked="" type="radio"/> None Required <input type="radio"/> Any Number <input type="radio"/> Blocked/Missing <input type="radio"/> Is This # <input type="radio"/> Is Not This # <input type="text"/>	

- **Call Answered** – Whenever a call is answered on the phone.
 - **Call Type** – Select the call type for the ringing call.
 - **Call Direction** – Select the direction of the call to be triggered.
 - **Caller ID Number** – Select a Caller ID number. For the last two options, enter a specific number in the box including wild card characters when needed. See Like Matches and Unlike Matches for use of wildcards.
 - **Extra Info** – Select a “Field Name” (CallerID Name, or type in another field name) and then choose how to treat this information. For the last two options, enter a specific number in the box including wildcard characters when needed. See Like Matches and Unlike Matches for use of wildcards.
 - **Account Code** – Select the account code type to be used. For the last two options, enter a specific number in the box including wildcard characters when needed. See Like Matches and Unlike Matches for use of wildcards.

2. Conditions: (If these Conditions are True)

<p>Call Type:</p> <input checked="" type="radio"/> Any <input type="radio"/> IC Only <input type="radio"/> Outside Only	<p>Extra Info:</p> <p>CallerID Name <input type="text"/></p> <input checked="" type="radio"/> None Required <input type="radio"/> Is Present <input type="radio"/> Is Missing <input type="radio"/> Is This Value: <input type="text"/>
<p>Call Direction:</p> <input checked="" type="radio"/> Any <input type="radio"/> Incoming <input type="radio"/> Outgoing Only	<p>Account Code:</p> <input checked="" type="radio"/> None Required <input type="radio"/> Any Number <input type="radio"/> Is Missing <input type="radio"/> Is This # <input type="radio"/> Is Not This # <input type="text"/>
<p>Caller ID Number:</p> <input checked="" type="radio"/> None Required <input type="radio"/> Any Number <input type="radio"/> Blocked/Missing <input type="radio"/> Is This # <input type="radio"/> Is Not This # <input type="text"/>	

Personal Call Handler

Creating Personal Call Handling Rules

- **Call Disconnect** – Whenever a call leaves the phone (whether the caller hung up or the call was transferred or forwarded).
 - Call Type – Select the call type for the ringing call.
 - Call Direction – Select the direction of the call to be triggered.
 - Call was Answered – Select whether the call was answered.
- **Net Phone Startup** – Happens whenever the Net Phone software starts up and is in full operation with the PBX.
- **Net Phone Shutdown** – Happens whenever Net Phone software is shutdown (using a normal Exit).

2. Conditions: (If these Conditions are True)

Call Type: <input checked="" type="radio"/> Any <input type="radio"/> IC Only <input type="radio"/> Outside Only	Call was Answered: <input checked="" type="radio"/> Doesn't Matter <input type="radio"/> Yes <input type="radio"/> No
Call Direction: <input checked="" type="radio"/> Any <input type="radio"/> Incoming Only <input type="radio"/> Outgoing Only	

2. Conditions: (If these Conditions are True)

- **FWDed/XFRed Call Ringing** – Whenever a call rings on the phone that has been either Forwarded or Transferred from another extension.

- Call Type – Select the call type for the ringing call.
- Phone State – Select the Phone State when the call arrives.
- FWD/XFR Ext # – Select the extension number the call is from. For the last two options, enter a specific number in the box including wild card characters when needed.

See Like Matches and Unlike Matches for use of wildcards.

- Extra Info – Select a “Field Name” (CallerID Name, or type in another field name) and then choose how to treat this information. For the last two options, enter a specific number in the box including wildcard characters when needed. See Like Matches and Unlike Matches for use of wildcards.
- Account Code – Select the account code type to be used. For the last two options, enter a specific number in the box including wildcard characters when needed. See Like Matches and Unlike Matches for use of wildcards.
- **ACD Call Ringing** – Happens whenever a call rings on the phone that is part of an ACD group (ignores non-ACD calls).
 - Call Type – Select the call type for the ringing call.
 - Phone State – Select the Phone State when the call arrives.
 - ACD Pilot Ext # – Select the pilot number the call is from. For the last two options, enter a specific number in the box including wild card characters when needed. See Like Matches and Unlike Matches for use of wildcards.
 - Extra Info – Select a “Field Name” (CallerID Name, or type in another field name) and then choose how to treat this information. For the last two options, enter a specific number in the box including wildcard characters when needed. See Like Matches and Unlike Matches for use of wildcards.
 - Account Code – Select the account code type to be used. For the last two options, enter a specific number in the box including wildcard characters when needed. See Like Matches and Unlike Matches for use of wildcards.

Personal Call Handler

Creating Personal Call Handling Rules

- **Status is Idle** – Whenever the station is idle and the DND button is toggled or whenever an ACD agent ends “wrapup” time and becomes available to take a call.
 - Do Not Disturb Status – Select whether the station is to be considered idle when the DND Status is...
 - ACD Agent Status – Check the box to trigger when an agent goes idle after completing the “wrap-up”.
- **Change in DND Status** – Whenever the DND or message status change takes place, the message set is checked to see if it matches the defined conditions.
 - Do Not Disturb Change – Select the DND Status change to cause the trigger. For the item with a message to match, enter the beginning characters of the message. See Like Matches and Unlike Matches for use of wildcards.
 - Affected Phone – Select whether this rule will be based upon My Phone or My Secondary Extension.

2. Conditions: (If these Conditions are True)

Do-Not-Disturb Status:
Only Idle when...
 DND is On
 DND is Off
 DND is On or Off

ACD Agent Status:
Only Idle when...
 Wrap-up is Completed and Agent is "Available"

2. Conditions: (If these Conditions are True)

Do-Not-Disturb Change:
 On or Off
 Turned Off
 Turned On
 Turned On with Message:
Msg Begins with:

Affected Phone:
 My Phone
 My Secondary Extension

- **Outlook Calendar Appointment** – An event that occurs at the start time of the appointment and again when the appointment time ends ('Free').
 - Calendar Status – Select to match the Outlook Calendar Status options: Any, Free, Busy, Out of Office.
 - Event Importance – Select to match the Outlook Calendar Importance options: Any, Low, Normal, or High.
 - Subject – Select either Any or Matches this Subject. For making the match enter the text for the subject to match. See Like Matches and Unlike Matches for use of wildcards.

2. Conditions: (If these Conditions are True)

<p>Calendar Status:</p> <input checked="" type="radio"/> Any <input type="radio"/> 'Free' <input type="radio"/> 'Busy' <input type="radio"/> 'Out of Office'	<p>Event Importance:</p> <input checked="" type="radio"/> Any <input type="radio"/> 'Low' <input type="radio"/> 'Normal' <input type="radio"/> 'High'
<p>Subject:</p> <input checked="" type="radio"/> Any <input type="radio"/> Matches this Subject: <input type="text"/>	

Note Outlook Calendar may also send a 'Tentative' status setting which is treated using the 'Any' setting.

- **Outlook Calendar Reminder** – An event that occurs at the time scheduled for sending the reminder message for an upcoming appointment. This event will trigger again if the appointment time is changed after the Reminder event was previously given.
 - Calendar Status – Select to match the Outlook Calendar Status options: Any, Free, Busy, Out of Office.
 - Event Importance – Select to match the Outlook Calendar Importance options: Any, Low, Normal, or High.
 - Subject – Select either Any or Matches this Subject. For making the match enter the text for the subject to match. See Like Matches and Unlike Matches for use of wildcards.

2. Conditions: (If these Conditions are True)

<p>Calendar Status:</p> <input checked="" type="radio"/> Any <input type="radio"/> 'Free' <input type="radio"/> 'Busy' <input type="radio"/> 'Out of Office'	<p>Event Importance:</p> <input checked="" type="radio"/> Any <input type="radio"/> 'Low' <input type="radio"/> 'Normal' <input type="radio"/> 'High'
<p>Subject:</p> <input checked="" type="radio"/> Any <input type="radio"/> Matches this Subject: <input type="text"/>	

Note Outlook Calendar may also send a 'Tentative' status setting which is treated using the 'Any' setting.

Like Matches

When you design a Rule to trigger using a Specific Number (for the CallerID number or Account number) or on a Specific Name (for the CallerID name) you can design the rule to either search for an exact match or a “LIKE” match. A “LIKE” match simply uses wildcard characters in the string that you specify to accept a range of values. The following wildcards are available:

?Any single character

*Zero or more characters

#Any single digit (0-9)

Example 1: To trigger on any caller from your area code 602: Set the Specific Number on Caller ID Number to: 602*

Example 2: To trigger on any caller from your local office code 496: Set the Specific Number on Caller ID Number to: 602496?

Example 3: To trigger on any caller with a caller ID name starting with C: Set the Specific Name on Caller ID name to: C*.

Unlike Matches

In addition, you can precede any of the search strings with the characters <> to request all matches that "aren't equal" or "aren't Like".

Example: To trigger on any caller from NOT from your area code 602: Set the Specific Number on Caller ID Number to: <>602*.

Step 2: Apply User-Defined Actions

This section will define how to apply the User-Defined Actions to a Personal Call Handling Rule.

- Set an Immediate Action – Pull down the listing and select the action to be applied immediately. Either an Immediate or a Delayed Action is needed for the rule to be complete.
- Set a Delayed Action – Define the number of seconds to delay the action and then pull down the listing and select the action to be applied. Both immediate and delayed actions can be performed in the same rule.
- To Check the Action – Clicking the Check Action button will transfer you to User Defined Actions to allow changing the action and/or test the action. See “User-Defined Actions” on page 26 for details.
- To Add an Action – Click the Add Action button to transfer to User Defined Actions to allow you to create a new action to be used. See “User-Defined Actions” on page 26 for details.
- To Delete an Action – Click the Delete Action button to remove an action from the listings. Use this with caution, as this will remove the action for all other functions as well.

Step 3: Step 3: Complete the Rule

- To Save Rule – Click the Save button to save your changed or new rule.
- To Cancel Settings – Click Cancel to exit without saving the settings.
- To Export Call Handler Rule – Click the Export Rule to create a .RUI file in the PC user’s “ÖDocument and Settings\Application Data\CTS\NetPhone” folder. Each rule created can be saved as a file for backup purposes and copying to another PC to allow the same rule to be used by other users.

Export Rules

Once a rule has been designed, exporting the rule is recommended to provide a backup copy and that file can be copied to other Net Phones. To export a rule, you will need to be in the Add/Edit Rule screen and click the Export Rule button. Pressing Export Rule copies the details of the rule into a special file named: xx.RUI where 'xx' is a number assigned by the system corresponding to the rule number (i.e. 2.ACI).

The file is exported into the user's application data folder (typically, "Ö\Documents and Settings\<user name>\Application Data\CTS\NetPhone"). In order to identify the file more easily you may then want to use Explorer to rename that file to something more appropriate (i.e. PLAYBELL.RUI). When renaming a rule file always limit the file name to 8 characters prior to the .RUI extension. This file can then be copied to another PC to give a copy of the rule to another user of the Net Phone. Leaving a copy in this folder will provide a backup copy of the rule that will be loaded at startup of Net Phone if that rule had been somehow deleted in the Personal Call Handler Rules List (see Importing Rules below for more details).

Note When exporting a rule, if a file with that name already exists, an error message will occur and the rule will not be copied – when this occurs you will need to use Explorer to rename the existing file and then export again.

Importing Rules

When the Net Phone program starts up, it automatically imports rules from the compiled NET_PHN.RUL rules file plus all rule files (*.RUX) it finds in its startup folder. The last character used in the file name extension defines how the rule file is treated when importing:

- .RUI – These files are individual rules created by exporting. These will be imported only when a rule using the same name does not exist in the compiled file. Thus, when this file exists and the user made changes to this rule, the user can revert back to the original operation by deleting the current rule in Net Phone then stopping and restarting Net Phone.
- .RU1 – Upon startup, Net Phone always imports rules from all “One-Shot” rule files (*.RU1). When a rule with the same name exists, the rule will be overwritten. Once imported, the One-Shot export file is deleted. These one-shot files can thus be used to import a rule just one time allowing the user to change or delete the rule as desired.
- .RUO – Upon startup, Net Phone always imports all “Over-Write” rule files, which overwrites any rule of the same name. These files can be useful to ensure the rules do not get changed or when wanting to make the same update on other Net Phones.
- .RU0 – These are another type of rule file that is imported only at initial startup of the program or when the compiled rules file “AGT_PHN.RUL” is not found at startup.

These types of files allow you to design a rule, export it, rename as needed and then copy the exported file to all PCs that need that rule. These are also useful to overcome a user accidentally deleting a rule, since exiting and restarting Net Phone will restore that rule.

This page is intentionally left blank.

Using Companion Applications **8**

Net Phone provides a powerful open architecture that allows companion applications to add features and functions. These companion applications inherit the look-and-feel of Net Phone and act as if they are “part of the Net Phone” and are provided as Options Buttons on the Main Screen.

Net Phone ships with several companion applications, including Call History, Extension Directory, Feature Directory, Personal Speed Dial Directory, Extra Buttons, and an Integrated Web Browser.

The companion applications rollout and dock to the bottom of Net Phone and are accessed using the Option Buttons with their name. Users may also detach the companion applications and place them anywhere on the desktop.

Directories

Several of the companion applications use a listing window that is shared, thus selecting another Option Button will replace the contents of the window. These applications are the Extension Directory, any Personal Directory, the Feature Code Directory, and Speed Dial Lists. These applications have several characteristics in common such as sorting and finding entries.

Sorting Entries

Click on a column header will sort the entries using that column. Click the same column header again to reverse the sort from ascending to descending (or vice versa). A small arrow in the header indicates the current column used for sorting and the direction is indicated by ↑ for ascending and ↓ for descending.

Finding Entries

The Find window used in conjunction with the sort column is used to quickly locate desired entries in large directories. Select a column where the entry is to be found, enter into the Find window characters to match.

- By Last Name – Sort using the Name column then start typing letters to find the name. Enter additional letters to narrow the search. Note: The find feature is not case-sensitive. Typing an “A” is the same as typing an “a”.
- By First Name – When using a format of “lastname, firstname”, you may search for matching first names by first typing a comma (“,”) in the find window, followed by letters of the desired first name.
- By Number – To find entries by extension, first sort by the Extension header, then enter numbers to narrow the search.
- By Other Columns – Select that column by clicking on the header, then start entering characters into Find to narrow the search.

Clear the contents of the Find entry to display the contents of the entire directory.

Extension Directory

List of names and extensions on the PBX phone system.

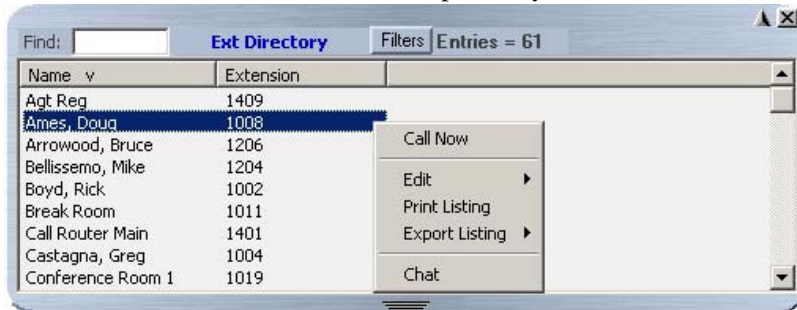

- To Call – Press Enter to dial the highlighted number, or double-click the desired name from the list.
- Drag and Drop to Create DSS Button – Drag an entry from the Directory to a Programmable User button to automatically create a DSS button with the selected extension number.

- **Additional Options** – Right-click on the entry to access a menu of the other functions:

Note Not all options may be available due to the settings for the Option Button.

- Call Now – Place a phone call to this person or extension. (Same as double-clicking.)
- Edit – Allows you to Add, Change, Delete, and Copy entries (typically available only in the Personal directory).
- Print Listing – Print a listing of all entries shown in the directory. Change the position and width of the columns to format the printout as desired. Use Filters and Find to print only the entries you want.
- Export Listing – Export the listing using either a CSV or Text format.
- Chat – Initiate a chat call to the person at this extension (Extension directory only, target must have Chat installed and running.)
- Filtering Out Unwanted Entries – Many PBX systems use default names for unassigned extensions. You may not want these unnecessary entries in the Directory, so Net Phone provides a Filter to remove certain items from the list.
 - Press the Filters button to access the Directory Filters screen appears.
- Enable the Hide Names option to enable the filter.

Note The Filters button changes from black to red to indicate Filters are active on the directory list.

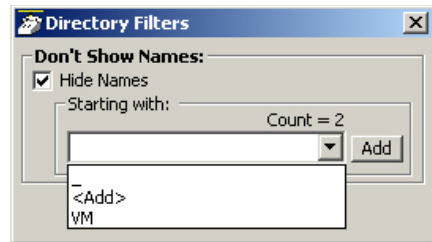

- To Add a Filter Entry – Use the pull down list and select <Add> to begin entering a new filter. Type in the characters to be filtered and press Enter or click the Add button.
- To Delete a Filter Entry – Use the pull down list and select an entry to be removed and press Del.

The filter strings are case sensitive and will hide all entries starting with exactly the same string of characters. Entering “A” hides all entries that begin with an uppercase A.

Speed Dial Directory

List of telephone numbers. The user may add entries to provide fast access to frequently dialed numbers.



- To Call – Press Enter to dial the highlighted number, or double-click the desired number from the list.
- Add by Drag and Drop from Outlook – Drag a contact from Microsoft Outlook to the Directory and automatically add to the list.
- Add by Drag and Drop from Call History – Drag a number from the “Call History” window to the Directory to add the number to the list.
- Drag and Drop to Create Speed Dial Button – Drag an entry from the Directory to a Programmable User button to automatically create a speed dial button with that phone number.
- Additional Options – Right-click on the entry to access a menu of other functions:
- Call Now – Place a phone call to this person or extension. (Same as double-clicking.)
- Edit – Allows you to Add, Change, Delete, and Copy entries (typically available only in the Personal directory).
- Lookup in Outlook – Lookup this number in Microsoft Outlook and open the matching contact.
- Print Listing – Print a listing of all entries shown in the directory. Change the position and width of the columns to format the printout as desired. Use Filters and Find to print only the entries you want.
- Export Listing – Export the listing using either a CSV or Text format.

Call History

Net Phone automatically creates a log of calls dialed and received on the local telephone extension. This Call History provides the user with a valuable log of his or her phone calls.

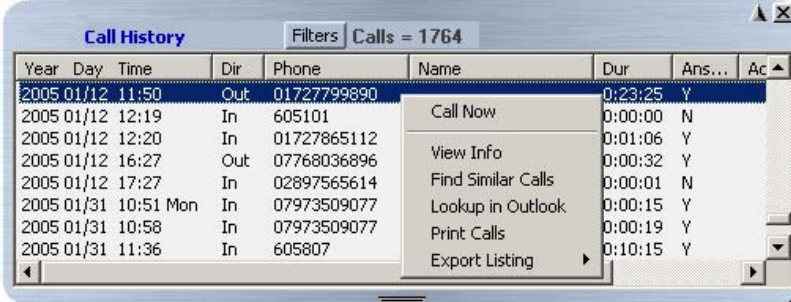

The screenshot shows a window titled "Call History" with a sub-header "Filters Calls = 1764". The window contains a table with the following columns: Year, Day, Time, Dir, Phone, Name, Dur, Ans..., and Ac. The table lists several call records, and a context menu is open over the first row, showing options like "Call Now", "View Info", "Find Similar Calls", "Lookup in Outlook", "Print Calls", and "Export Listing".

Year	Day	Time	Dir	Phone	Name	Dur	Ans...	Ac
2005	01/12	11:50	Out	01727799890		0:23:25	Y	
2005	01/12	12:19	In	605101	Call Now	0:00:00	N	
2005	01/12	12:20	In	01727865112		0:01:06	Y	
2005	01/12	16:27	Out	07768036896	View Info	0:00:32	Y	
2005	01/12	17:27	In	02897565614	Find Similar Calls	0:00:01	N	
2005	01/31	10:51 Mon	In	07973509077	Lookup in Outlook	0:00:15	Y	
2005	01/31	10:58	In	07973509077	Print Calls	0:00:19	Y	
2005	01/31	11:36	In	605807	Export Listing	0:10:15	Y	

- Pages Buttons – Call History automatically creates ‘pages’ when the log becomes too large. Use the ‘Previous’ and ‘Next’ buttons to move between the various pages. Call History creates Pages when the call log exceeds a certain number of Call records to improve performance. Call History displays Page Buttons and Page Count when extra pages are active.
- Pages Count – Call History displays the current page number and the total number of pages. “(2 of 2)” indicates you are currently viewing Page 2, and there are 2 pages. The last page contains the most recent calls.
- Calls Count – Displays the total number of calls currently listed on the page. Note: The number of Calls shown may be less than the actual total if Filters are active.
- Call Information – Each call in the call history appears as one line in the Call Display area. The column headers indicate what information is shown in each column.
 - Year Day Time – Shows the date and time that the call completed (not started). This column also includes the day-of-week for the first call of each day.
 - Dir – The direction of the call, either “In” (incoming) or “Out” (outgoing).

Using Companion Applications

Call History

- Phone – the phone number you dialed (outgoing,) or the CallerID Number / ANI (incoming.)
- Name – The name of the person you called (based on Outlook), or who called you (based on CallerID.)
- Dur –The Duration or length of time the call spent on this Net Phone extension, in hours, minutes, and seconds. This time does not include any time the call spent on any other extensions before or after being on this extension.
- Ans – Boolean (Y/N) indicator shows whether the call was answered while it was on this Net Phone extension. Note: This flag is only valid on incoming calls. Net Phone cannot detect when an outgoing call is answered, so it must assume all outgoing calls are answered.
- Acct Code – Shows the account code, if any, that was attached to this call. Customers often use Account Codes to indicate something about the call, such as the Customer ID, the result code of the call (i.e. “order was placed”, “needs follow-up”, “unable to reach – party was busy”), etc. This account code could have been attached to the call prior to reaching this phone, or it could have been added or changed by you while it was on your extension. Call History logs the current Account Code when the call leaves the Net Phone extension.
- Notes – Shows the ‘Notes’ that were taken during this call. These Notes could have been attached to the call prior to reaching this phone, and/or they could have been added or changed by you while it was on your extension. Call History logs the current set of Notes when the call leaves the Net Phone extension.
- To Call – Double-click the desired number from the list.
- Drag and Drop to Call – You can select a call and then use your mouse to drag and drop it to either the Call window or the LCD Display to start the dialing of that number.
- Drag and Drop to Create Speed Dial Button – You can select a call and then use your mouse to drag and drop it to a Net Phone button.
- Drag and Drop to Add to Speed Dial List – You can select a call and then use your mouse to drag and drop it to your Personal Directory.

- Additional Options – Right-click on the entry to access a menu of other functions:
 - Call Now – Dial the phone number using Net Phone.
 - View Info – Provides a read-only view of all of the information about the call, including the “Notes.” Note: You cannot change this information – you can view and copy/paste it to other applications.

View Call Information

Date/Time: 2005 03/16 14:11 Done

Time: 14:11

Dir: Out

Phone: 480-496-9040

Name: Computer Telepho

Dur: 0:00:23

Ans: y

Acct Code:

Type: CO

Notes:

- Find Similar Calls – Enables the Filters option pre-configured with information to match the selected call. This is very useful for finding calls made to or received from a certain person or phone number.
- Lookup in Outlook – Look up the telephone number in Microsoft Outlook and open any matching Contact.
- Print Calls – Prints a listing of all entries shown in Call History. Change the position and width of the columns prior to printing to format the printout as desired. The “Print Size Warning” dialog appears when your printout exceeds more than a few pages.

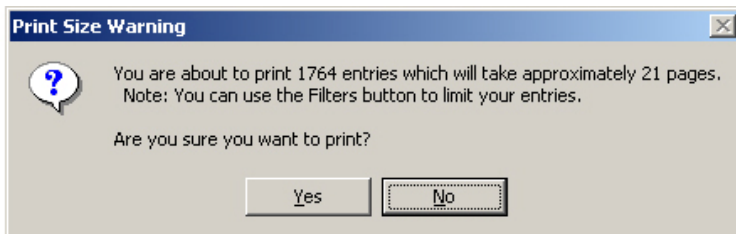

- Export Listing – Export the listing using either a CSV or Text format.
- Listen to Call – When the Tracer Integration is provided, this button provides a link to Replay to allow the recording to be played back.
- **Filtering** – Use filters to limit the number of calls or view a certain type of calls. For example, you might want to see only the calls you made/received in the last 7 days. Or you want to see all Outgoing calls made to a specific area code since the first of the year.
 - Press the “Filters” button to open the Call History Filters screen.
 - Select the options and data for the calls that you want to see.
 - Dates – Select the date(s) – “All” means any date.
 - Call Direction – Choose whether you want to see incoming (“In Only”), outgoing (“Out Only”), or all calls (“In & Out”).
 - Phone Numbers – Choose “All” for calls made to/from any number. Use the “Matching” option to limit the search to calls made to/from specific numbers. You can enter a specific phone number (like 480-496-9040,) the last part of a number (496-9040,) or the first part of a number (480+) to find all matching calls. You may also use wild cards, such as: 480-???-9040 and 480-496* .
 - Names – Choose “All” for calls to/from any name including blank names. Use the “Starting with” option to limit the search to calls with a specific name. Enter an entire name (Jack Jones) or just the first part of a name (Jac). The name search is NOT case sensitive.

- Account Codes – Choose “All” for calls with any or no account code. Use the “Starting with” option to limit the search to calls matching or starting with a specific account code. For example, ‘123’ returns calls with account codes 123 and 123xxx.
- Press the Search button to find the calls (on the current page) that match ALL of the selected options. Call History will update the “Calls” counter and “Call Display” area on the main screen.

The screenshot shows a dialog box titled "Call History Filters". It has a standard Windows-style title bar with a close button. The dialog is organized into several sections, each with a bolded title and radio button options. The "Dates" section has "All" selected, with "Today", "Last 12 days", and "Since 2/10/2005" as other options. The "Call Direction" section has "In & Out" selected, with "In Only" and "Out Only" as other options. The "Phone Numbers" section has "All" selected, with "Matching: 480+" as another option. The "Names" section has "All" selected, with "Starting with:" followed by an empty text input field. The "Account Codes" section has "All" selected, with "Starting with:" followed by an empty text input field. At the bottom of the dialog are three buttons: "Search", "Clear Filters", and "Cancel".

- Search Button – Finds the calls (on the current page) that match ALL of the selected filtering options.
- Clear Filters Button – Resets all filters to ‘Off’. Press Search to re-load all Call History record. Or, select new filter settings and start a new Filter search.
- Cancel Button – Closes the filters screen with no update to the “Calls Display”.

Note The Filters button changes from Black to Red when Filters are active. This serves to remind you that the Call Display list may not display all Call records while Filters are active.

Browser Window

Net Phone provides an integrated web browser window for access to Internet or Intranet locations, or direct access to local HTML files. In addition to basic browsing, you can create custom web applications to extend the functionality of Net Phone for your business.

For example, your call center could have incoming calls automatically open the Net Phone browser window to a “Caller Survey” page. The Call Survey page could display information about the caller and display an answering script the agent could use to guide the conversation. The web page might also allow the agent to enter answers from the caller into HTML forms and submit the results to a company web server.

The Net Phone Web Window is based on Microsoft Internet Explorer. You must have Internet Explorer 4.0 or higher installed on the PC.



Presence Viewer

► To assign the Presence Viewer to one of Net Phone buttons

The Presence View can be assigned to one of the Options Keys.

1. Right click the Options Key and select the Change Key.

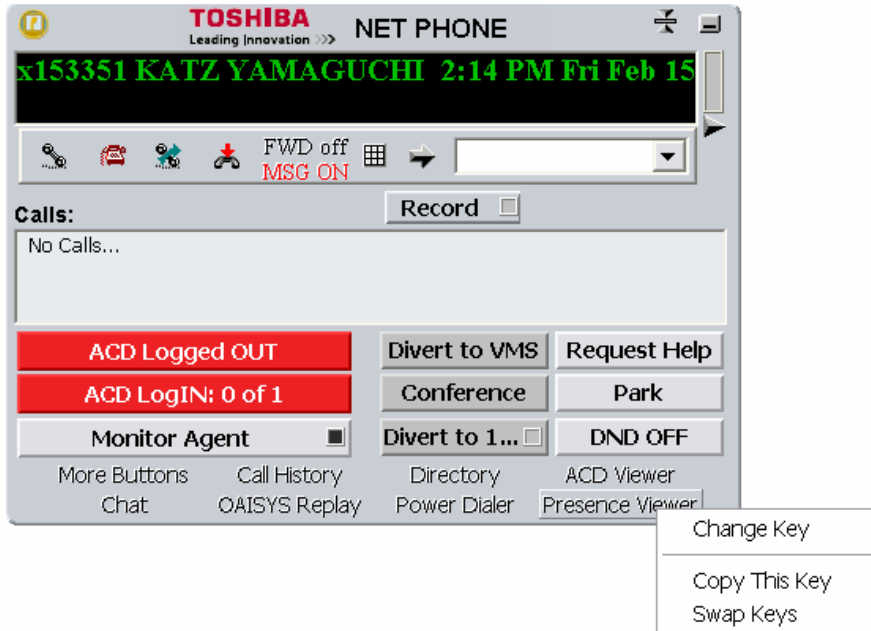

2. In the Set Options Key window, select Presence Viewer from the Key Type drop down menu. Assign any name to Key Label shown on the Options Button or Tool Tip shown as the mouse over text.

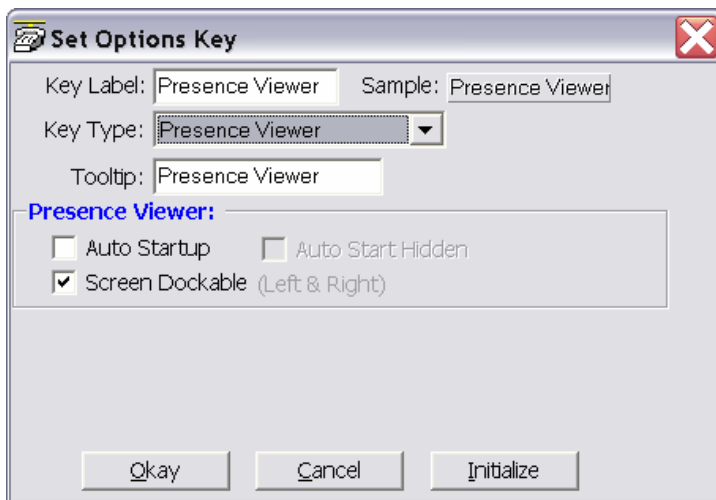

► To manage the Presence Viewer

1. Click the Options Key assigned for the Presence Viewer.
2. To manage the group, right click on My Group in the left pane and select Change this Group.

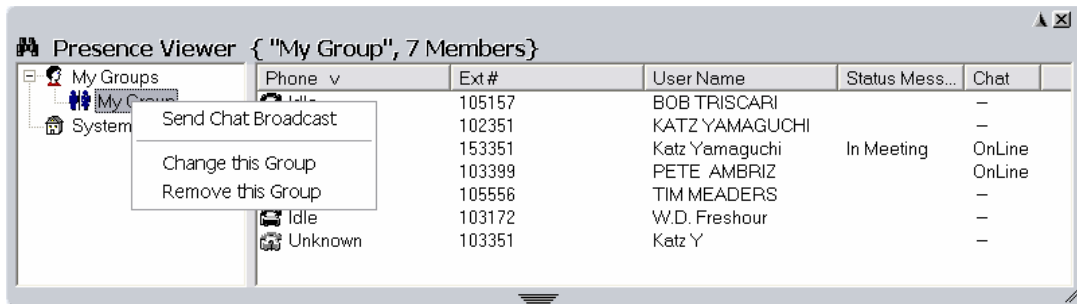

3. Use the double arrow buttons to add or remove users from the group (shown right).

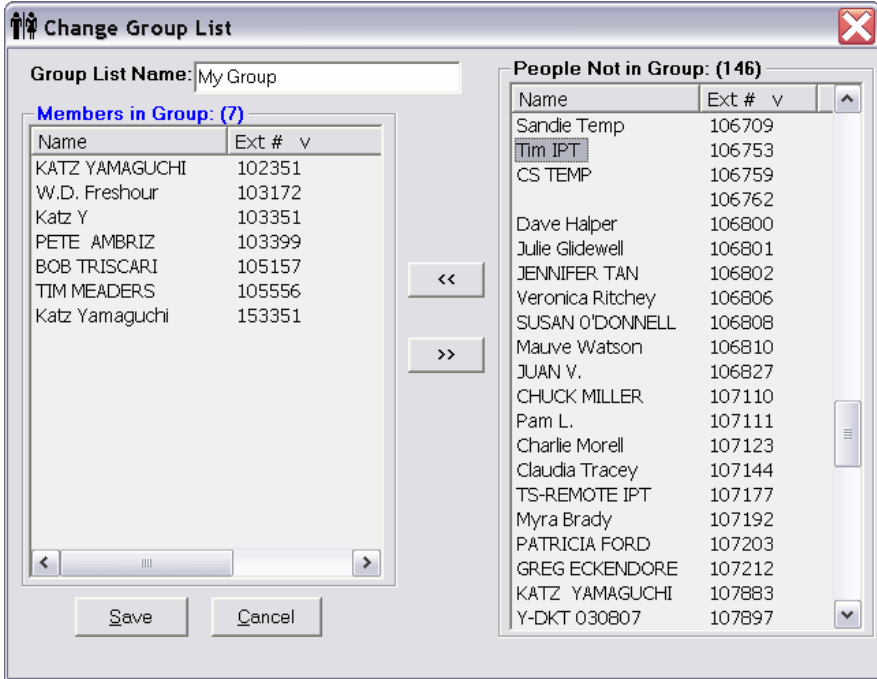

► To use the Presence Viewer

The Presence Viewer window shows the status of users.

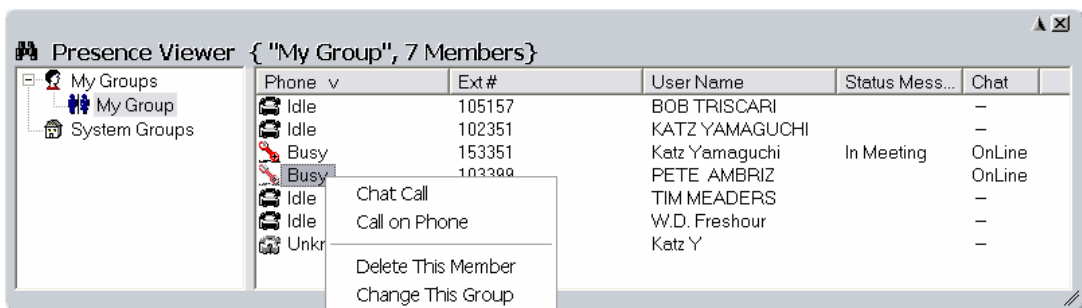

- Right click the member to start Chat or call the person through Net Phone.

Note The binocular icon on the top left provides menus such as Sort or Icon view as well as Help.

Other Applications

Several other applications integrate with Net Phone. For more details on these applications, please see the documentation on each of these products.

Chat

An integrated text-messaging function that allows you communicate with other Net Phone users using text messaging ‘calls’ even while you’re busy on the phone. See the Chat User Guide for instructions on its use.

Personal Power Dialer

Allow you to automatically call a list of phone numbers or dial phone numbers at specified dates and times. See the Power Dialer User Guide for instructions on its use.

Replay

OAISYS Replay is a client application for OAISYS Tracer. Replay must be installed on this PC to access call history and recorded files from Tracer. See the Replay User Guide for instructions on its use.

Index

A

- about this book
 - conventions, [vi](#)
 - organization, [v](#)
 - related documents, [vii](#)
- account code, [48](#)
- account number, [51](#)
- ACD call ringing, [101](#)
- ACD Keys, [43](#)
- ACD key view, [15](#)
- ACT, [1](#)
- action keys, [43](#)
- actions
 - creating actions, [47](#)
 - importing, [71](#)
 - testing, [72](#)
- action variables, [67](#)
- always on top, [14](#)
- answer, [42](#)
- audio control, [5](#)
- auto startup, [36, 37](#)

B

- bank of buttons, [35](#)
- browser, [118](#)
- browser button, [35](#)
- buttons
 - ACD, [6](#)
 - browser, [35](#)

- call handler, [10](#)
- call handling, [3](#)
- call history, [34](#)
- chat, [36](#)
- close, [9, 10](#)
- debug files, [28](#)
- dial, [4](#)
- dial pad, [4](#)
- dock, [9, 10](#)
- expand, [3](#)
- extension, [vi](#)
- minimize, [3](#)
- option, [3](#)
- options, [30](#)
- power dial, [37](#)
- programmable, [6](#)
- recording button, [5](#)
- replay, [38](#)
- side window rollout, [3](#)
- smart, [86](#)
- speed dial, [33](#)
- user programmable, [10](#)

buttons mode, [10](#)

C

- calendar, [19](#)
- Call
 - info, [6](#)
 - Window, [6](#)

- call
 - answered, 99
 - control, 42
 - disconnect, 100
 - extra call info, 77
 - forward, 3
 - history, 15, 113
 - logging, 15
 - modify, 51
 - results, 21
 - retrieve, 78
 - ringing, 98, 101
 - transfer, 66
 - types, 15
 - variables, 67
 - call center, 81
 - call forwarding, 80
 - call handler mode, 9
 - call handler rules, 9, 93
 - add or change, 97
 - creating, 96
 - delete, 96
 - call history, 38
 - call info
 - export, 49
 - calls
 - answering, 75
 - hold, 78
 - outgoing, 73
 - transferring, 76
 - chat, 31, 36, 122
 - color
 - back, 40
 - default, 40
 - text, 40
 - companion application windows, 11
 - conference, 42
 - contact
 - add, 19
- D**
- DDE message, 59
 - dial, 42
 - area code, 23
 - dial buffer, 4
 - dialing
 - hot key, 29, 74
 - on-screen, 73
 - dial pad, 4
 - dialpad, 74
 - directories, 109
 - directory
 - extension, 110
 - speed dial, 112
 - Do Not Disturb, 63
 - Do-Not-Disturb, 3
 - drag and drop, 45, 74
 - DSS message, 92
- E**
- enable sound, 15
 - exporting actions, 70
 - extension directory, 31
 - extension number, vi
 - extra info, 16
 - feature, 16
- F**
- feature code, 40
 - features, 73
 - field name, 52
 - forwarding, 64
- G**
- Goldmine, 1

H

hangup, 42

headset

controls, 85

installation, 84

operation, 85

trouble shooting, 87

volume control, 86

help, 8

hold, 42

home area code, 18, 20, 23

outside, 24

I

importing actions, 71

initialize key, 39

Insight, 48

K

key

ACD, 43

action, 43

change, 40

copy, 39

DSS extension, 44

feature code, 40

initialize, 39

label, 40

PBX command, 42

run program, 45

speed dial, 41

swap, 39

system, 42

web, 44

keys

combination, 62

creating keys, 45

special, 61

keystrokes, 60

L

LCD display, 3

local dialing plan, 20, 22

logging in or out, 81

log string, 50

lookup, 50

low profile, 14

M

menu

advanced, 28

chat, 31

message waiting, 15

Microsoft, 1

Outlook, 1

Windows '98, 1

Windows 2000, 1

Windows NT 4.0, 1

Windows Vista, 1

Windows XP, 1

mobile user, 15

N

name, 51

Net Phone

expanded view, 5

features, 73

file menu, 8

functions, 1

help, 8

main menu, 7

main screen, 2

setup menu, 8

shutdown, 100

startup, 100
streamlined view, 2

O

OAISYS, 38
 auto call record, 5
 Tracer, 5, 38
On manual dialing, 18
options, 28
outlook
 calendar, 92, 103
 dialing, 89
 incoming calls, 89
 lookup, 50
outlook integration, 18
outside numbers, 21

P

PCH rules, 94
personal directory, 33
personal power dialer, 37, 122
phone forwarding, 64
phone number, 51
 test, 24
phone screen, 50
pop up, 14
popup, 29
power dialer, 21
preferences, 13
 user, 14
presence, 119
programmable keys, 39

R

ready to dial, 21
re-dial, 73
redial, 4

Replay, 38
replay, 122
resize, 10
run program, 45

S

screen
 phone, 50
 popup call info, 56
setup preferences, 13
shortcut keys, 29
side window
 rollout, 9
 screen, 9
skins, 12
skin selection, 12
sound file, 15
speed dial, 33
 directory, 112
 keys, 41
 list, 74
standard info, 51
static information fields, 16
status, 102
 agent, 82
status message, 64
status messages, 79
swap keys, 39
system variables, 69

T

tabs
 advanced, 26
 dialing, 20
 docking, 25
 general, 14
talk indication, 86
TAPI service provider, 26

TASKE Contact, [48](#)
testing actions, [72](#)
transfer, [42](#), [66](#)
trunk access code, [20](#)

U

URL, [35](#), [53](#), [54](#)
user defined action Keys, [43](#)
user Preferences, [14](#)

V

value, [52](#)
variables, [67](#)
 system, [69](#)
views
 regular screen-docked, [7](#)
 screen docked, [7](#)
 slim screen-docked, [7](#)
volume controls, [5](#)

W

WAV file, [53](#)
web browser, [35](#), [53](#), [54](#)
web keys, [44](#)

This is the last page of the document.